

# lichtmacher

*Wir bringen Licht*

*Profilleuchten*



# Profil 46

## Profillängen:

- 841mm
- 1121mm
- 1401mm
- 1681mm
- 1961mm
- 2241mm

## Leistung:

- 21W-132W

## Lichtfarben:

- 2700k
- 3000k
- 4000k

## Weitere Optionen:

- Dimmbarer Dali Treiber
- CRI >90
- Gehäuse in Weiss, Schwarz oder Alu
- URG 19 (Micro-P)
- Nur direkte Lichtverteilung

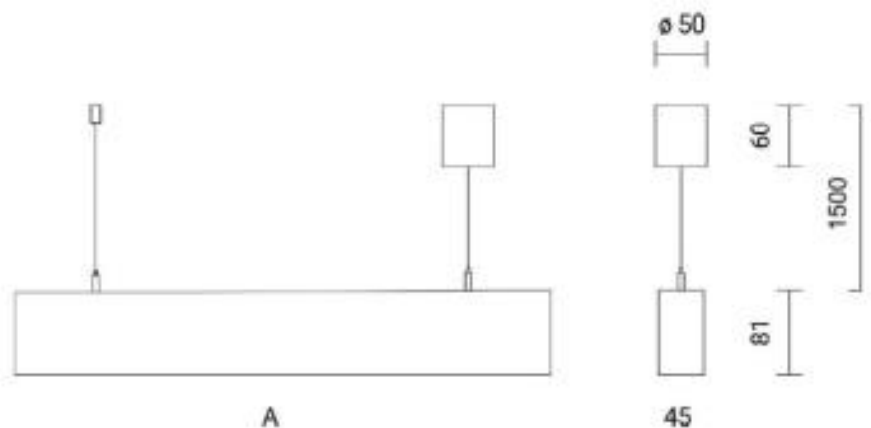



# Profil 50



## Profillängen:

- 841mm
- 1121mm
- 1401mm
- 1681mm
- 1961mm
- 2241mm

## Leistung:

- 14W-113W

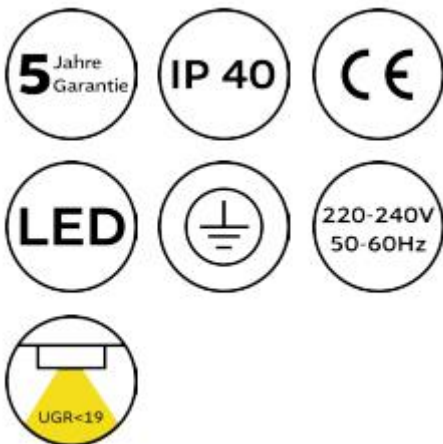

## Lichtfarben:

- 2700k
- 3000k
- 4000k

## Weitere Optionen:

- Dimmbarer Dali Treiber
- CRI >90
- Gehäuse in Weiss, Schwarz oder Alu
- URG 19 (Micro-P)



A



45

# Profil 47

## Profillängen:

- 561mm
- 841mm
- 1121mm
- 1401mm
- 1681mm
- 1961mm
- 2241mm

## Leistung:

- 9W-113W

## Lichtfarben:

- 2700k
- 3000k
- 4000k

## Weitere Optionen:

- Dimmbarer Dali Treiber
- CRI >90
- Gehäuse in Weiss, Schwarz oder Alu
- URG 19 (Micro-P)
- Dark Light Optik

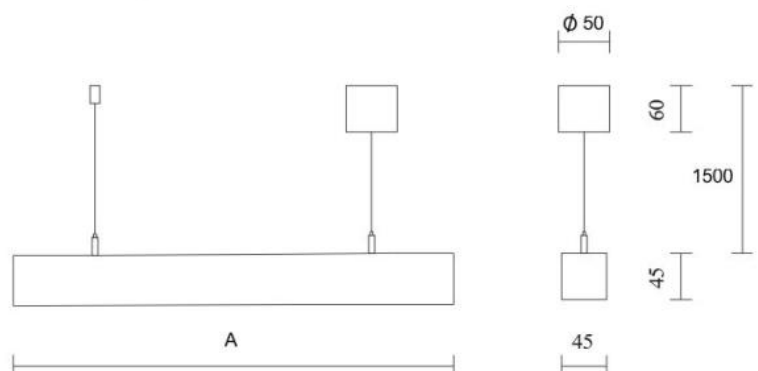
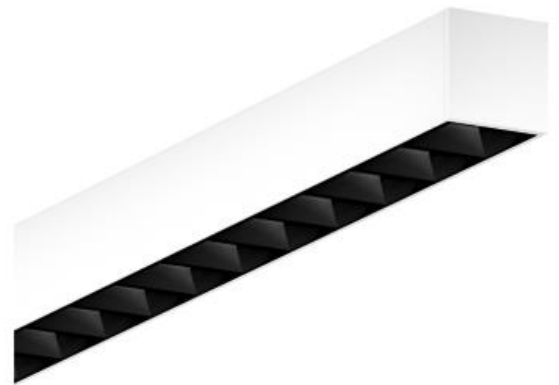
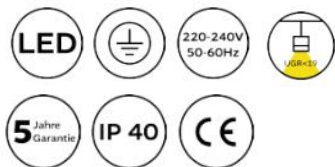

# Profil 48

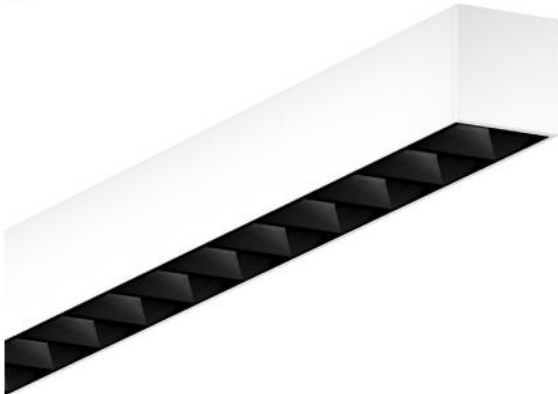

## Profillängen:

- 561mm
- 841mm
- 1121mm
- 1401mm
- 1681mm
- 1961mm
- 2241mm

## Leistung:

- 9W-113W

## Lichtfarben:

- 2700k
- 3000k
- 4000k

## Weitere Optionen:

- Dimmbarer Dali Treiber
- CRI > 90
- Gehäuse in Weiss, Schwarz oder Alu
- UGR 19 (Micro-P)
- Dark Light Optik

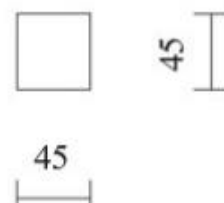
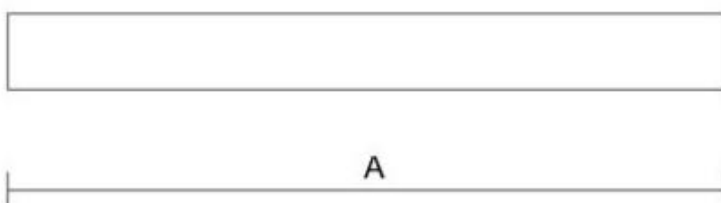
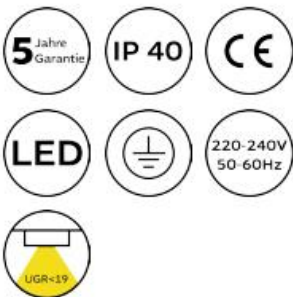

# Profil 61

## Profillängen:

- 841mm
- 1121mm
- 1401mm
- 1681mm
- 1961mm
- 2241mm

## Leistung:

- 22W-144W

## Lichtfarben:

- 2700k
- 3000k
- 4000k

## Weitere Optionen:

- Dimmbarer Dali Treiber
- CRI >90
- Gehäuse in Weiss, Schwarz oder Alu
- URG 19 (Micro-P)

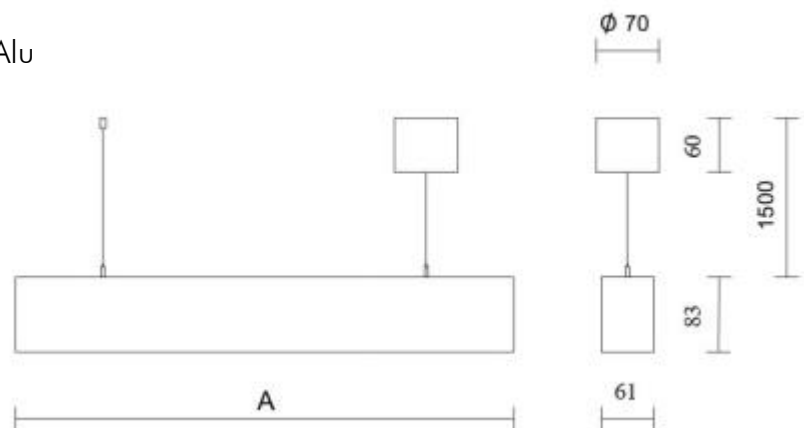
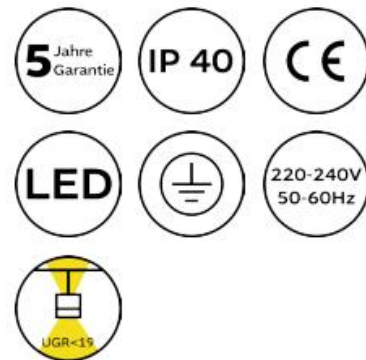



# Profil 63



## Profillängen:

- 561mm
- 841mm
- 1121mm
- 1401mm
- 1681mm
- 1961mm
- 2241mm

## Leistung:

- 9W-113W

## Lichtfarben:

- 2700k
- 3000k
- 4000k

## Weitere Optionen:

- Dimmbarer Dali Treiber
- CRI > 90
- Gehäuse in Weiss, Schwarz oder Alu
- UGR 19 (Micro-P)

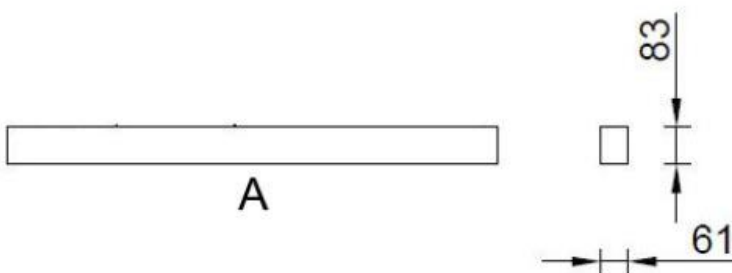
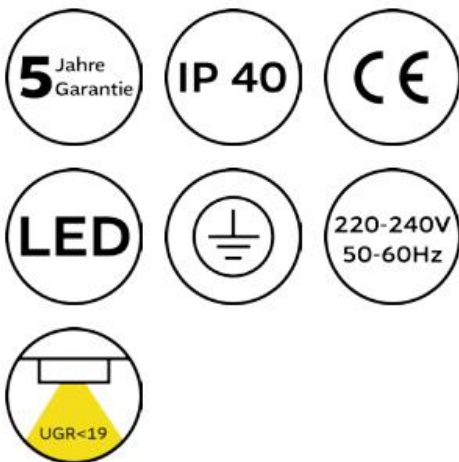



# Profil 67



## Profillängen:

- 562mm
- 842mm
- 1122mm
- 1402mm
- 1682mm
- 1962mm
- 2242mm

## Leistung:

- 9.4W-64.8W



## Lichtfarben:

- 2700k
- 3000k
- 4000k

## Weitere Optionen:

- Dimmbarer Dali Treiber
- CRI >90
- Gehäuse in Weiss, Schwarz oder Alu

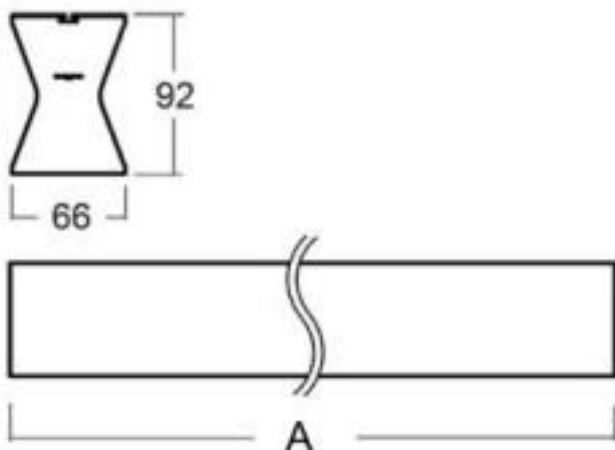



# Canto

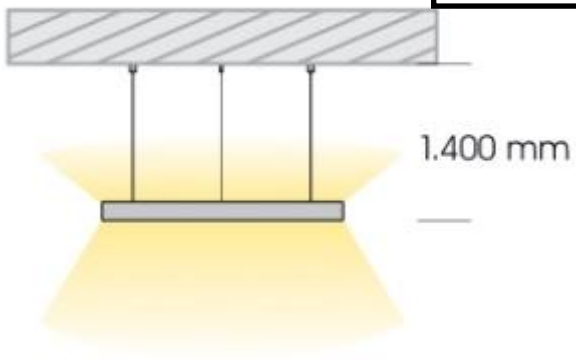
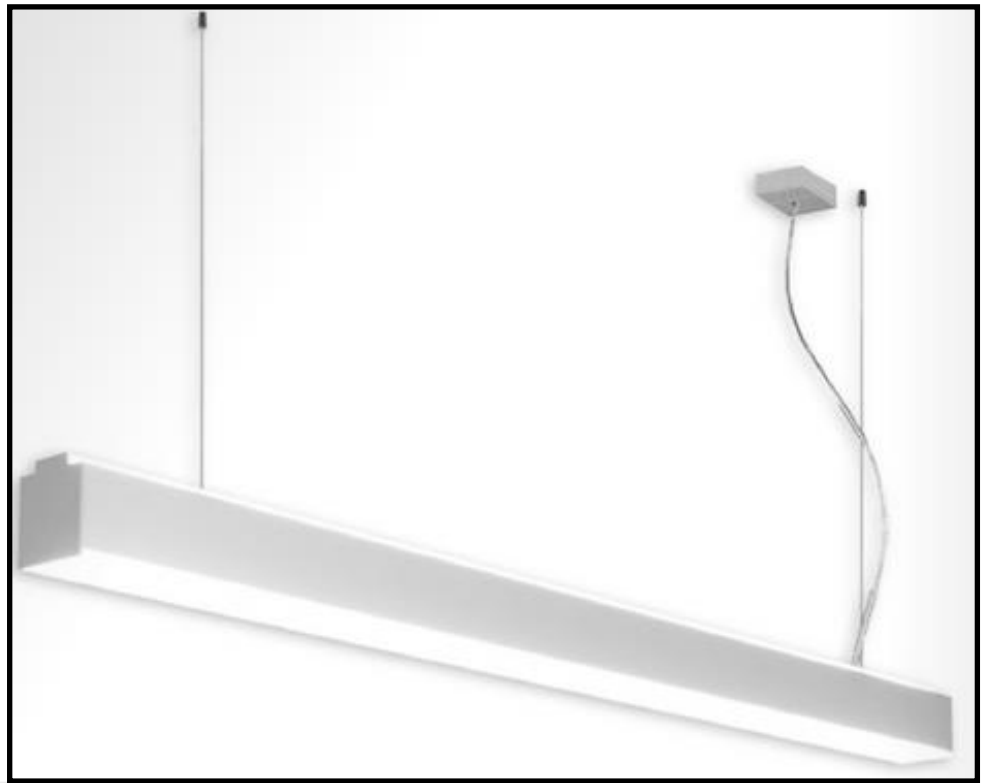

1.2m

42W

Direktes Licht &  
Indirektes Licht

1.2m

46W

Direktes Licht &  
Indirektes Licht

1.5m

53W

Direktes Licht &  
Indirektes Licht

1.5m

58W

Direktes Licht &  
Indirektes Licht



**L-Abdeckung (direkt/  
Indirekt)**

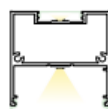

**H-Abdeckung (direkt/  
Indirekt)**



Profilfarben: Weiss, Schwarz, Silber, Nickel gebürstet

Lichtfarben: 3000K und 4000K

Nicht dim, Dim dali



Produkt	Farbe	Lichtfarbe	Abdeckung
8644-120	<div style="display: inline-block; border: 1px solid black; padding: 2px; margin-right: 10px;">1</div> Weiss <div style="display: inline-block; border: 1px solid black; padding: 2px; margin-left: 100px; margin-right: 10px;">3</div> Schwarz	<div style="display: inline-block; border: 1px solid black; border-radius: 50%; padding: 2px; margin-right: 10px;">1</div> 3000K	<div style="display: inline-block; border: 1px solid black; padding: 2px; margin-right: 10px;">1</div> H
	<div style="display: inline-block; border: 1px solid black; padding: 2px; margin-right: 10px;">2</div> Silber <div style="display: inline-block; border: 1px solid black; padding: 2px; margin-left: 100px; margin-right: 10px;">4</div> Nickel	<div style="display: inline-block; border: 1px solid black; border-radius: 50%; padding: 2px; margin-right: 10px;">2</div> 4000K	<div style="display: inline-block; border: 1px solid black; padding: 2px; margin-right: 10px;">2</div> L
8644-150	<div style="display: inline-block; border: 1px solid black; padding: 2px; margin-right: 10px;">1</div> Weiss <div style="display: inline-block; border: 1px solid black; padding: 2px; margin-left: 100px; margin-right: 10px;">3</div> Schwarz	<div style="display: inline-block; border: 1px solid black; border-radius: 50%; padding: 2px; margin-right: 10px;">1</div> 3000K	<div style="display: inline-block; border: 1px solid black; padding: 2px; margin-right: 10px;">1</div> H
	<div style="display: inline-block; border: 1px solid black; padding: 2px; margin-right: 10px;">2</div> Silber <div style="display: inline-block; border: 1px solid black; padding: 2px; margin-left: 100px; margin-right: 10px;">4</div> Nickel	<div style="display: inline-block; border: 1px solid black; border-radius: 50%; padding: 2px; margin-right: 10px;">2</div> 4000K	<div style="display: inline-block; border: 1px solid black; padding: 2px; margin-right: 10px;">2</div> L

Beispiel: 8644-120-  -  -



# Ramon

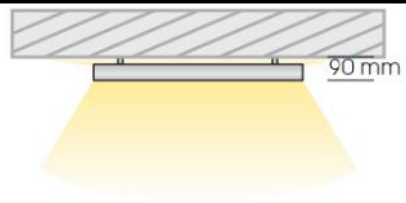
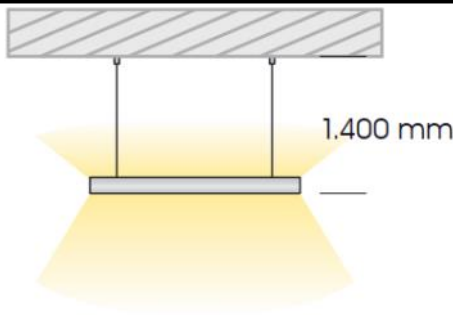
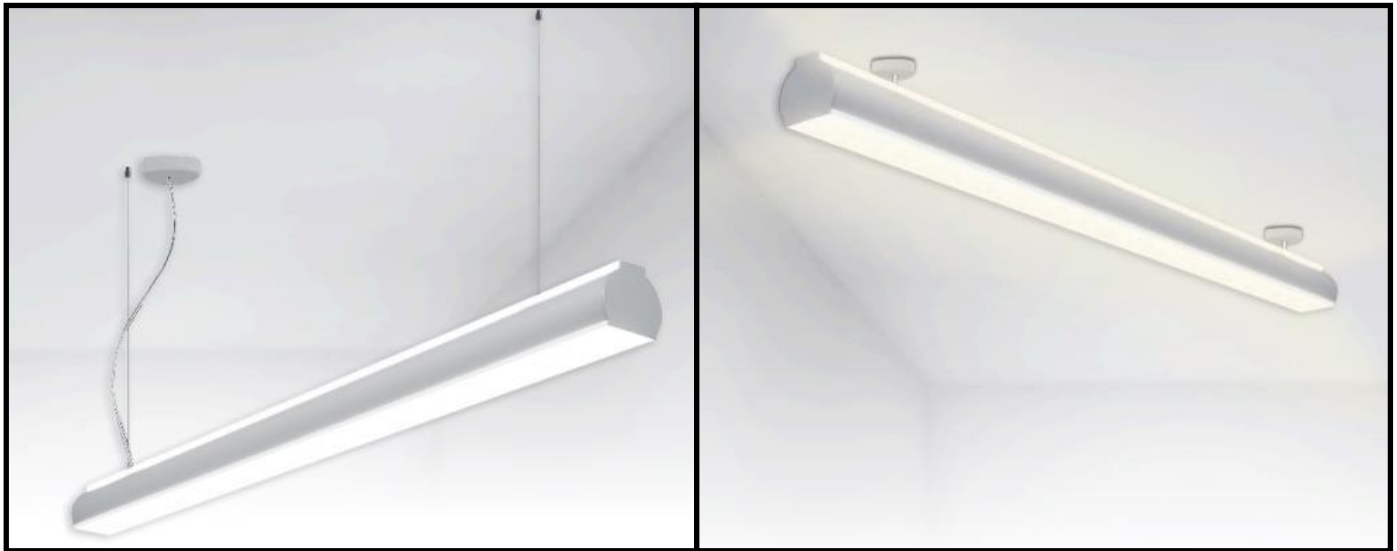

1.2m	42W	Direktes Licht & Indirektes Licht
1.5m	53W	Direktes Licht & Indirektes Licht

1.2m	46W	Direktes Licht & Indirektes Licht
1.5m	58W	Direktes Licht & Indirektes Licht



**L-Abdeckung (direkt/ Indirekt)**



**H-Abdeckung (direkt/ Indirekt)**



Profilfarben: Weiss, Schwarz, Silber, Nickel gebürstet  
 Lichtfarben: 3000K und 4000K  
 Nicht dim, Dim dali



Produkt	Farbe	Lichtfarbe	Abdeckung
8630-120	<span style="border: 1px solid black; padding: 2px;">1</span> Weiss <span style="margin-left: 100px;"><span style="border: 1px solid black; padding: 2px;">3</span> Schwarz</span>	<span style="border: 1px solid black; border-radius: 50%; padding: 2px;">1</span> 3000K	<span style="border: 1px solid black; padding: 2px;">1</span> H
	<span style="border: 1px solid black; padding: 2px;">2</span> Silber <span style="margin-left: 100px;"><span style="border: 1px solid black; padding: 2px;">4</span> Nickel</span>	<span style="border: 1px solid black; border-radius: 50%; padding: 2px;">2</span> 4000K	<span style="border: 1px solid black; padding: 2px;">2</span> L
8630-150	<span style="border: 1px solid black; padding: 2px;">1</span> Weiss <span style="margin-left: 100px;"><span style="border: 1px solid black; padding: 2px;">3</span> Schwarz</span>	<span style="border: 1px solid black; border-radius: 50%; padding: 2px;">1</span> 3000K	<span style="border: 1px solid black; padding: 2px;">1</span> H
	<span style="border: 1px solid black; padding: 2px;">2</span> Silber <span style="margin-left: 100px;"><span style="border: 1px solid black; padding: 2px;">4</span> Nickel</span>	<span style="border: 1px solid black; border-radius: 50%; padding: 2px;">2</span> 4000K	<span style="border: 1px solid black; padding: 2px;">2</span> L

Beispiel: 8630-120-   -   -  



# Ramon-D

**Pamalux**  
Leuchten

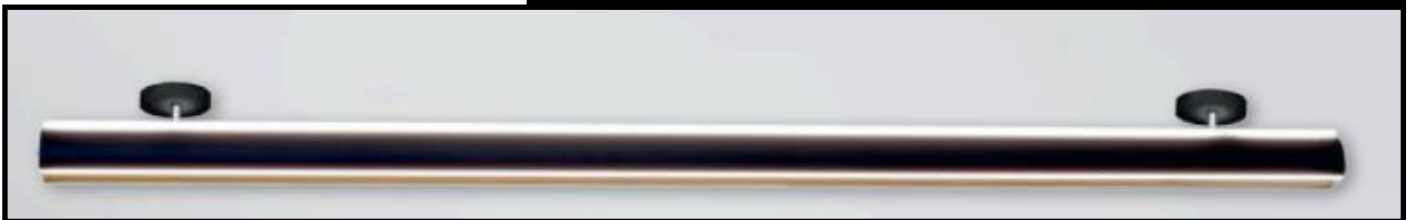

## Hänge & Deckenleuchte:

1.2m

42W

Direktes Licht &  
Indirektes Licht

1.5m

53W

Direktes Licht &  
Indirektes Licht

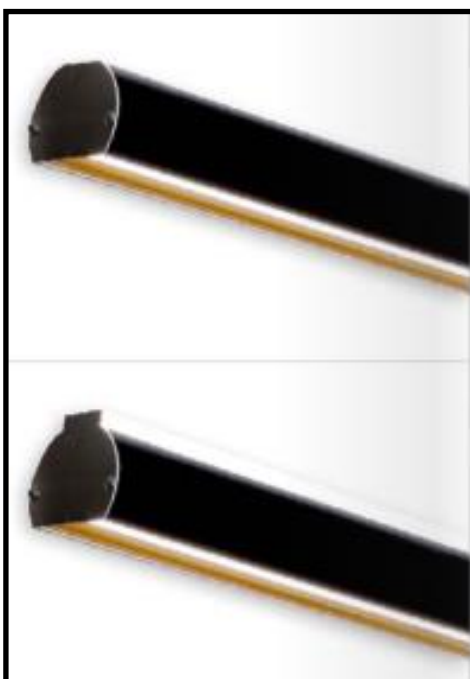

**L-Abdeckung (direkt/  
Indirekt)**



**H-Abdeckung  
(direkt/Indirekt)**

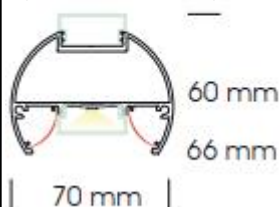

Profilfarben: Weiss, Schwarz, Silber, Ni-  
ckel gebürstet

Designreflektor Farbe: Gold, Silber,  
Weiss

Lichtfarben: 3000K und 4000K

Nicht dim, Dim dali

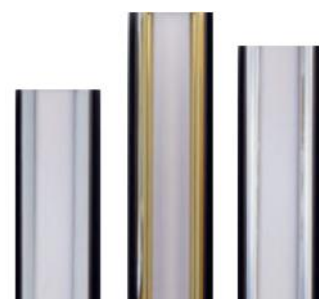

# Ramon-D

Produkt	Farbe	Lichtfarbe	Abdeckung
8643-120	1 Weiss 3 Schwarz	1 3000K	1 H
	2 Silber 4 Nickel	2 4000K	2 L
8643-150	1 Weiss 3 Schwarz	1 3000K	1 H
	2 Silber 4 Nickel	2 4000K	2 L
Farbe Reflektor	1 Weiss 3 Gold 2 Silber		

Beispiel: 8643-120- □ - ○ - ◇ - △



# lichtmacher

Wir bringen Licht

„ Dunkelheit existiert nicht, nur die Abwesenheit von Licht. “



Dies ist nur ein kleiner Ausschnitt aus unserem Gesamtsortiment.  
Fragen Sie uns an.