

# lichtmacher

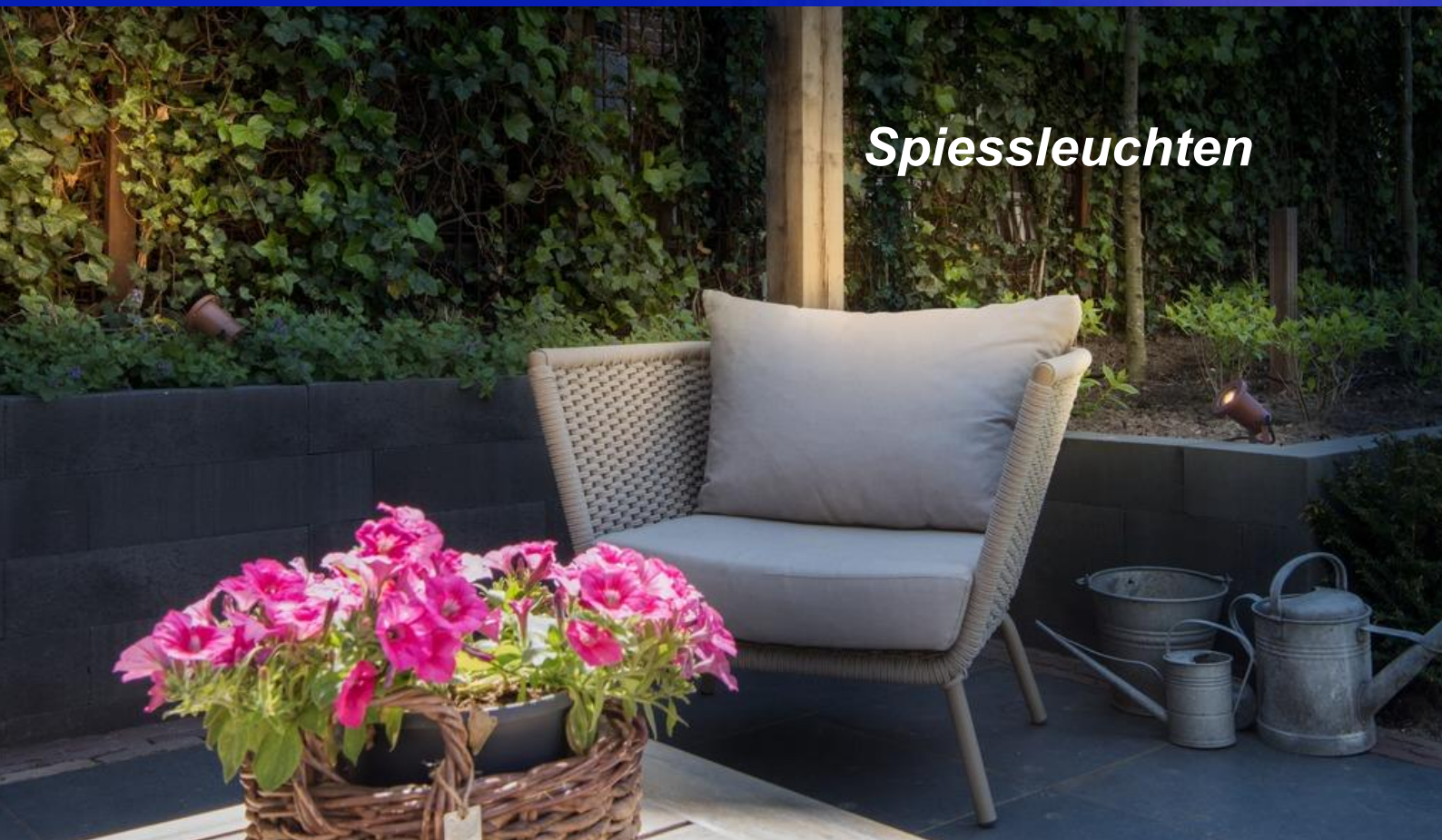

*Spiessleuchten*



# Slot

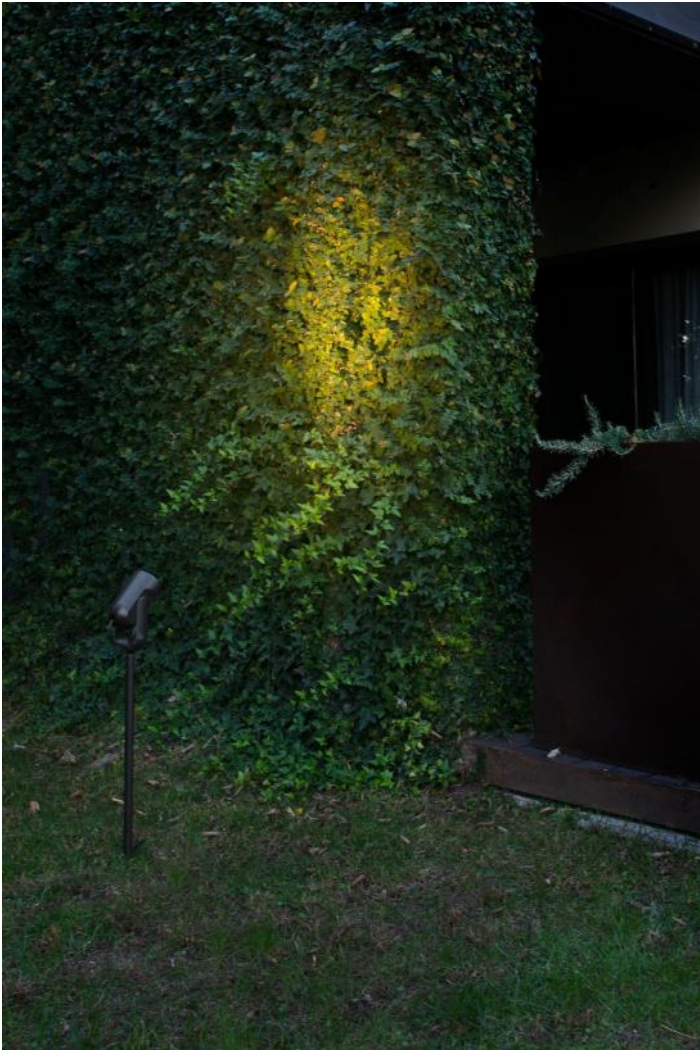

## Slot 500 spike

70038 ● Dark Grey/Gris Oscuro

**Material** Body Aluminium/Aluminio  
Diff Transparent Glass/Cristal Transparente

**Light Source** COB LED 13W 3000K 750lm

**CRI** >80

**Class** I

**Voltage (V/Hz)** 100V-240V/50-60Hz

**IP** 65

**IK** 08

**Beam angle** 28°

**Cable** 1.5 MT

Driver ✓



## Slot 500

70036 ● Dark Grey/Gris Oscuro

**Material** Body Aluminium/Aluminio  
Diff Transparent Glass/Cristal Transparente

**Light Source** COB LED 13W 3000K 750lm

**CRI** >80

**Class** I

**Voltage (V/Hz)** 100V-240V/50-60Hz

**IP** 65

**IK** 08

**Beam angle** 28°

Driver ✓

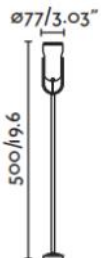

## Slot 200 spike

70037 ● Dark Grey/Gris Oscuro

**Material** Body Aluminium/Aluminio  
Diff Transparent Glass/Cristal Transparente

**Light Source** COB LED 13W 3000K 750lm

**CRI** >80

**Class** I

**Voltage (V/Hz)** 100V-240V/50-60Hz

**IP** 65

**IK** 08

**Beam angle** 28°

**Cable** 1.5 MT

Driver ✓

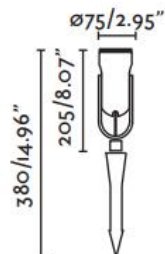

## Slot 200 spike

70037 ● Dark Grey/Gris Oscuro

**Material** Body Aluminium/Aluminio  
Diff Transparent Glass/Cristal Transparente

**Light Source** COB LED 13W 3000K 750lm

**CRI** >80

**Class** I

**Voltage (V/Hz)** 100V-240V/50-60Hz

**IP** 65

**IK** 08

**Beam angle** 28°

**Cable** 1.5 MT

Driver ✓



# Flow

- 71546  Matt Black/Negro Mate
- 71547  Beige

**Material** Body PC  
Diff Opal PC/PC Opal

**Light Source** 1 GU10 max. 5W  
**Bulb incl.** No  
**Recom. Bulb** 97685327  
**Class** II  
**IP** 65  
**Cable** 2.5 MT



## Spike accessory 60cm / Accesorio estaca 60cm

- 71548  Matt Black/Negro Mate
- 71549  Beige

**Material** Body Aluminium/Aluminio

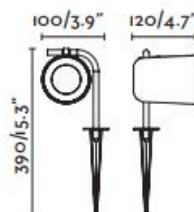
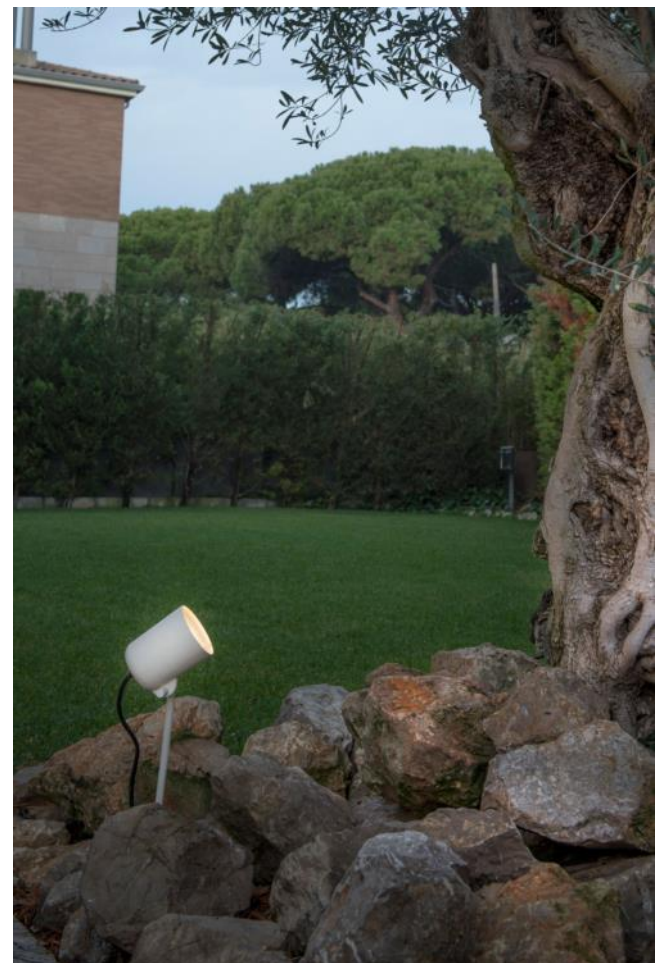



# Toni



71528

● Matt Black/Negro Mate

**Material**

**Body PC**

**Diff Transparent PC/PC Transparente**

**Light Source**

1 GU10 max. 5W

**Bulb incl.**

No

**Recom. Bulb**

97685327

**Class**

II

**IP**

65

**Cable**

2.5 MT

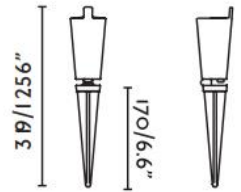

SEA SIDE  
SUITABLE

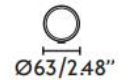

# Alfa by Àlex & Manel Llusçà

70025

● Dark Grey/Gris Oscuro

**Material**

**Body Aluminium/Aluminio**

**Diff Transparent Glass/Cristal Transparente**

**Light Source**

COB LED 13W 3000K 845lm

**CRI**

>80

**Class**

I

**Voltage (V/Hz)**

220V-240V/50-60Hz

**IP**

65

**Beam angle**

80°

Driver

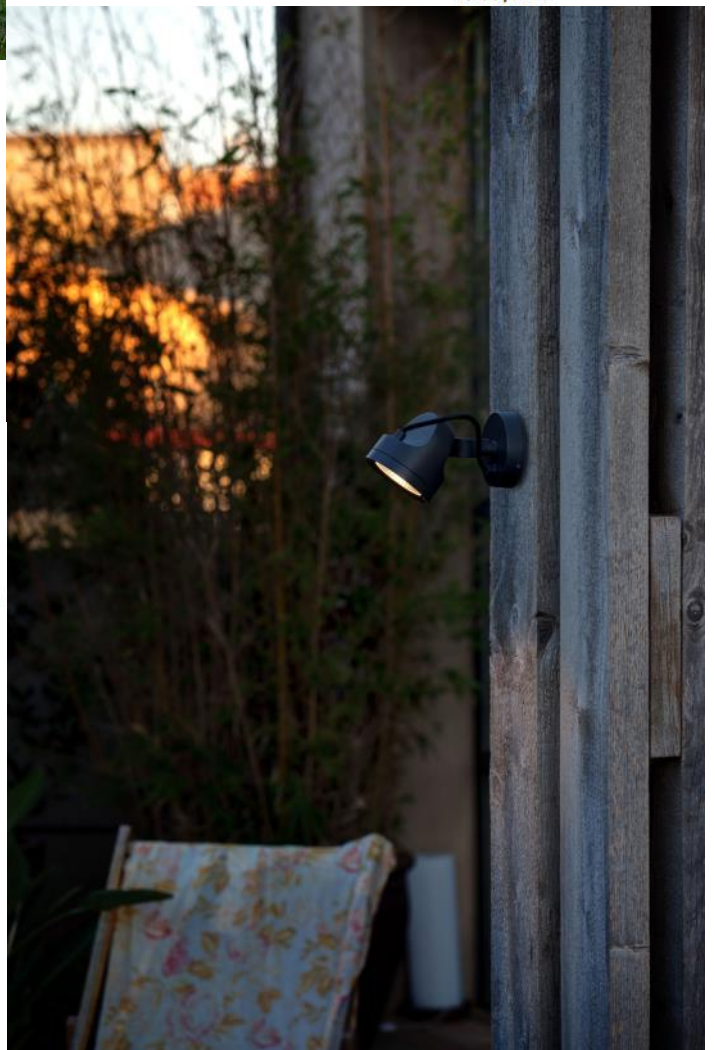
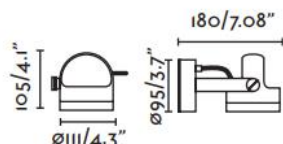

**70159** ● Dark Grey/Gris Oscuro

**Material** Body Aluminium/Aluminio  
Diff Transparent Glass/Cristal Transparente

**Light Source** COB LED 16W 3000K 800lm

**CRI** >80

**Class** I

**Voltage (V/Hz)** 220V-240V/50Hz

**IP** 65

**Beam angle** 36°

**Cable** 0.5 MT

Driver ✓

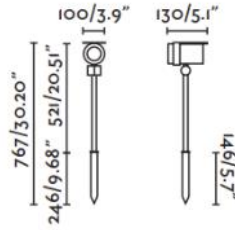

**70158** ● Dark Grey/Gris Oscuro

**Material** Body Aluminium/Aluminio  
Diff Transparent Glass/Cristal Transparente

**Light Source** COB LED 16W 3000K 800lm

**CRI** >80

**Class** I

**Voltage (V/Hz)** 220V-240V/50Hz

**IP** 65

**Beam angle** 36°

**Cable** 0.5 MT

Driver ✓

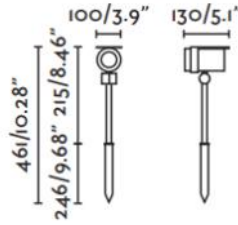

**Sobek**

**70151** ● Dark Grey/Gris Oscuro

**Material** Body Aluminium/Aluminio  
Diff Transparent Glass/Cristal Transparente

**Light Source** COB LED 7W 3000K 550lm

**CRI** >80

**Class** I

**Voltage (V/Hz)** 100V-240V/50-60Hz

**IP** 65

**IK** 06

**Beam angle** 50°

Driver ✓

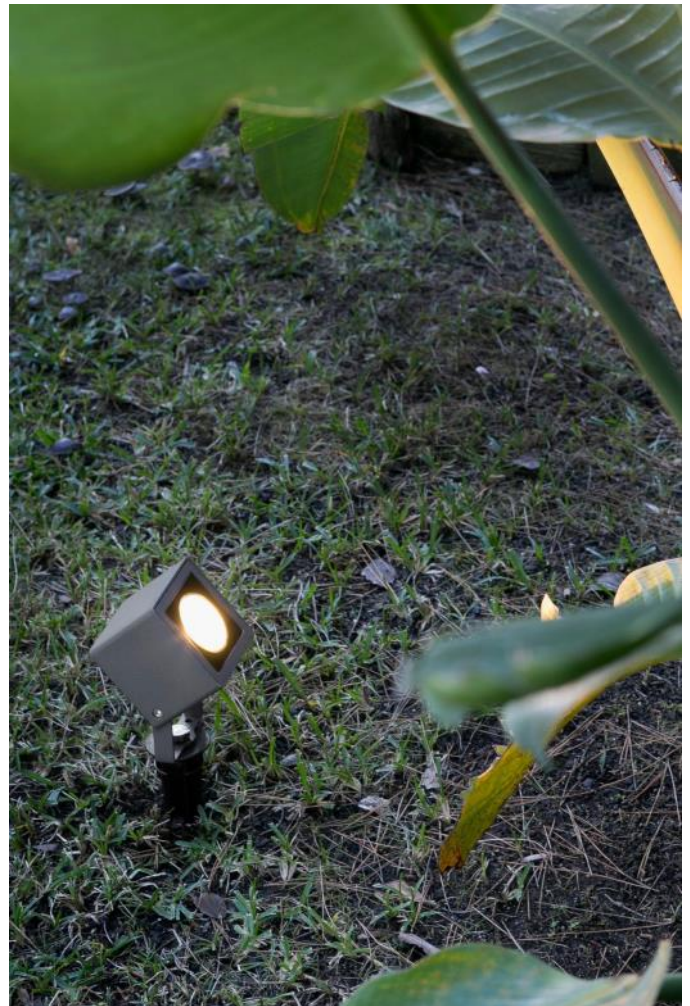
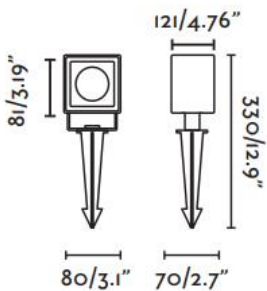



### Bamboù 1068

75556 ● Matt Black/Negro Mate

**Material** Body Aluminium/Aluminio  
Diff Transparent Glass/Cristal Transparente

**Light Source** LIGHT MODULE 8W 2200K 606lm

**CRI** >=80

**Class** I

**Voltage (V/Hz)** 200V-250V/50-60Hz

**IP** 65

**IK** 06

**Beam angle** 360°

**Cable** 0.2 MT

Driver ✓

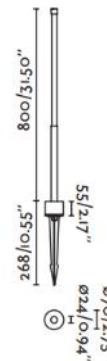

### Bamboù 1268

75557 ● Matt Black/Negro Mate

**Material** Body Aluminium/Aluminio  
Diff Transparent Glass/Cristal Transparente

**Light Source** LIGHT MODULE 8W 2200K 606lm

**CRI** >=80

**Class** I

**Voltage (V/Hz)** 200V-250V/50-60Hz

**IP** 65

**IK** 06

**Beam angle** 360°

**Cable** 0.2 MT

Driver ✓

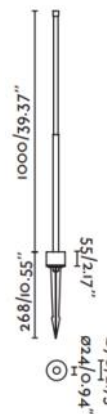

## Piccola

70245 ● Matt Black/Negro Mate  
70246 ● Matt White/Blanco Mate

**Material** Body Aluminium/Aluminio  
Diff Opal PMMA/PMMA Opal

**Light Source** SMD LED 6W 2700K 360lm

**CRI** >80

**Class** I

**Voltage (V/Hz)** 100V-240V/50-60Hz

**IP** 65

**IK** 08

**Cable** 1.5 MT

Driver ✓

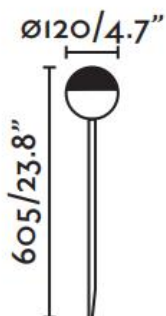

# Saigon out



## Saigon out 1500 R45

71575P-04

● ● Dark Grey/Gris Oscuro + White/Blanco

**Material**

**Body** Aluminium/Aluminio

**Shade** PEMD

**Light Source**

1 E27 max. 15W

**Bulb incl.**

No

**Recom. Bulb**

17463

**Class**

II

**IP**

44

**Cable**

2 MT

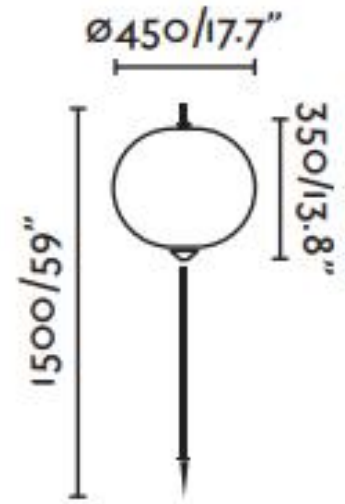

## Saigon out 870 R45

71576P-04

● ● Dark Grey/Gris Oscuro + White/Blanco

**Material**

**Body** Aluminium/Aluminio

**Shade** PEMD

**Light Source**

1 E27 max. 15W

**Bulb incl.**

No

**Recom. Bulb**

17463

**Class**

II

**IP**

44

**Cable**

2 MT

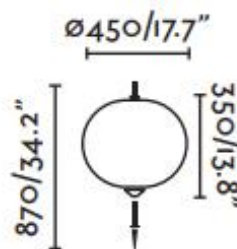

## Bezel

70248

● Matt Black/Negro Mate

Material

Body Aluminium/Aluminio

Diff Transparent Glass/Cristal Transparente

Light Source

COB LED 8W 2700K 349lm

CRI

$\geq 90$

Class

I

Voltage (V/Hz)

220V-240V/50-60Hz

IP

65

IK

06

Cable

1.2 MT

Driver

Ø40/1.575"

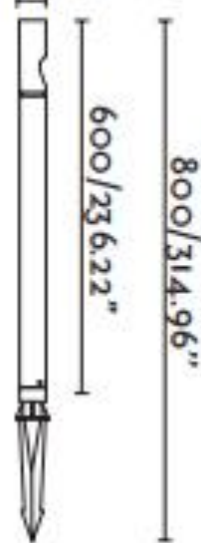





### Andy

71613 ● Satin Gold/Oro Satinado

**Material** Body Steel/Acero  
Diff Transparent PC/PC Transparente

**Light Source** 1 GU10 max. 5W

**Bulb incl.** No

**Recom. Bulb** 97685327

**Class** I

**IP** 65

**Cable** 2 MT

### Balder

70469 ● Matt Black/Negro Mate

**Material** Body Aluminium/Aluminio  
Diff Transparent Glass/Cristal Transparente

**Light Source** SMD LED 3W 3000K 110lm

**CRI** >80

**Class** I

**Voltage (V/Hz)** 100V-240V/50-60Hz

**IP** 67

**Beam angle** 50°

**Cable** 2 MT

Driver

### Plom

70913 ● Dark Grey/Gris Oscuro

**Material** Body Aluminium/Aluminio  
Diff Transparent PMMA/PMMA Transparente

**Light Source** COB LED 9W 3000K 635lm

**Dimmable W** 200lm / 635lm

**CRI** >80

**Class** I

**Voltage (V/Hz)** 100V-240V/50-60Hz

**IP** 64

**Cable** 0.3 MT

Driver

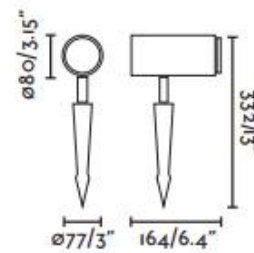
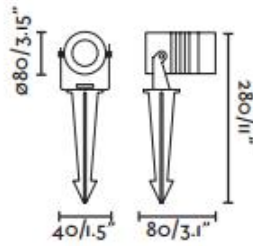
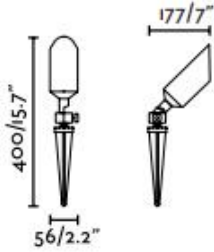

### Seth 600

70226 ● Matt Black/Negro Mate

**Material** Body Aluminium/Aluminio  
Diff Transparent PMMA/PMMA Transparente

**Light Source** SMD LED 6W 2700K 450lm

**CRI** >80

**Class** II

**Voltage (V/Hz)** 100V-240V/50-60Hz

**IP** 44

**Beam angle** 40°

**Cable** 2 MT

Driver

### Seth 280

70227 ● Matt Black/Negro Mate

**Material** Body Aluminium/Aluminio  
Diff Transparent PMMA/PMMA Transparente

**Light Source** SMD LED 6W 2700K 450lm

**CRI** >80

**Class** II

**Voltage (V/Hz)** 100V-240V/50-60Hz

**IP** 44

**Beam angle** 40°

**Cable** 2 MT

Driver

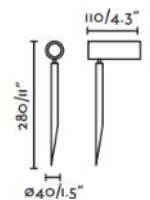
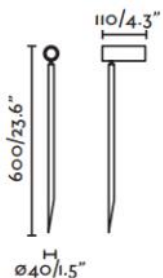

## NAUTILUS 10 SP, rund, QPAR51



220-240V ~50/60Hz  
Material: Aluminium

- IP44 Schutzkontaktstecker

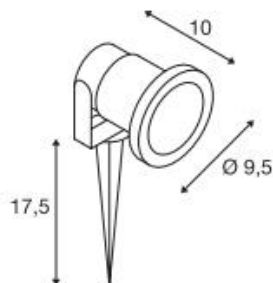

**SOCKET INSIDE** <35 W

Sockel: 1xGU10 max. L: 5.7 cm

Variante	Art.Nr.
● grau	227418



LED GU10 51mm | 6W | 38°  
2700K | 450lm | EEK=F  
6kWh/1000h

Art. Nr.: 1005077



## BIG NAUTILUS SP, rund, QPAR51



220-240V ~50/60Hz  
Material: Aluminium

- IP44 Schutzkontaktstecker

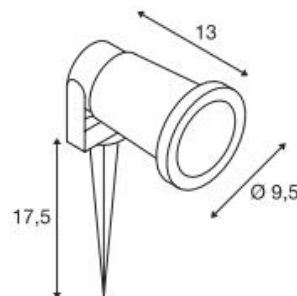

**SOCKET INSIDE** <11 W

Sockel: GU10 max. Ø: 5.1 cm | L: 8.3 cm

Variante	Art.Nr.
● schwarz	227410
● rost	1001964
● grün	1001965



LED GU10 51mm | 6W | 38°  
2700K | 450lm | EEK=F  
6kWh/1000h

Art. Nr.: 1005077



# NAUTILUS 10

SP, rund, QPAR51



220-240V ~50/60Hz  
Material: Edelstahl 316

- IP44 Schutzkontaktstecker

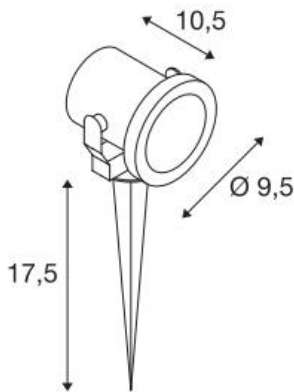

Socket: 1xGU10    max. Ø: 5.1 cm    L: 5.7 cm

Variante	Art.Nr.
● edelstahl	229740



Art. Nr.: 1005077

# NAUTILUS 10

SP, quadratisch

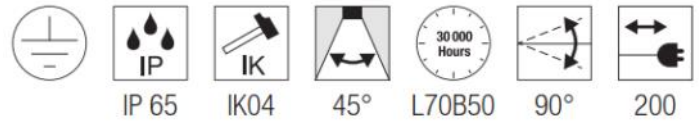

100-277V ~50/60Hz | 700mA  
Systemleistung: 8.5W  
Material: Aluminium / Glas

- IP44 Schutzkontaktstecker

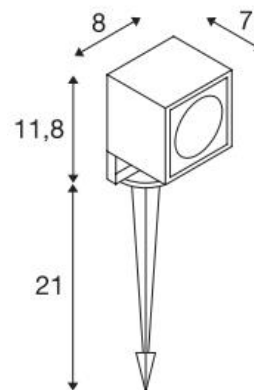

Down    660lm | 3000K

Variante	Art.Nr.
● anthrazit	231035

# LED SPIKE SP

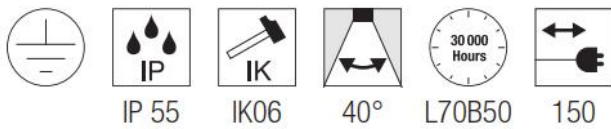

100-240V ~50/60Hz | 240mA  
Systemleistung: 6W  
Material: Aluminium / Glas

- IP44 Schutzkontaktstecker

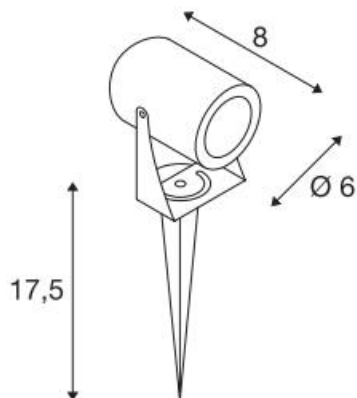

Down 400lm | 3000K

# SYNA SP

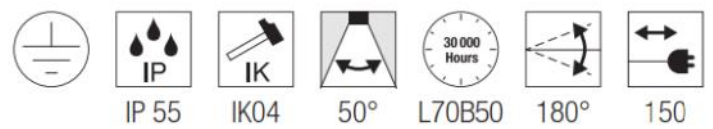

220-240V ~50/60Hz  
Systemleistung: 9W  
Material: Aluminium / Acryl

- IP44 Schutzkontaktstecker

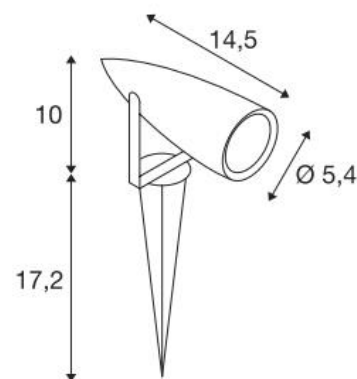

Down 470lm | 3000K

Variante	Art.Nr.
● anthrazit	1002201
● rost	1002203

Variante	Art.Nr.
● anthrazit	227505

# SITRA 360 SPIKE

SP, single, TCR-TSE



220-240V ~50/60Hz  
Material: Aluminium / Glas

- IP44 Schutzkontaktstecker

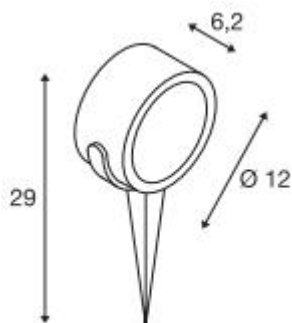

**SOCKET**  
**INSIDE**



Socket: 1xGX53 | max. Ø: 7.5 cm | L: 3.5 cm

**Variante**

**Art.Nr.**

- anthrazit

**231525**



LED GX53 | 6.1W | 120°  
3000K | 490lm | EEK=G  
6kWh/1000h



**Art. Nr.: 1005271**

# SITRA 360 SPIKE

SP, double, TCR-TSE



220-240V ~50/60Hz  
Material: Aluminium / Glas

- IP44 Schutzkontaktstecker

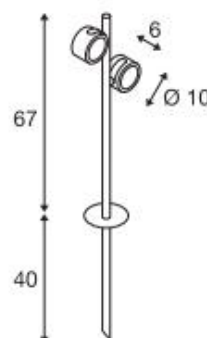

**SOCKET**  
**INSIDE**



Socket: 2xGX53 | max. Ø: 7.5 cm | L: 3.5 cm

**Variante**

**Art.Nr.**

- anthrazit

**231535**



LED GX53 | 6.1W | 120°  
3000K | 490lm | EEK=G  
6kWh/1000h



**Art. Nr.: 1005271**

# Clock



## CLOCK Ø 80 mm

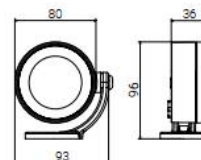

### Code

4661		AN - anthracite	3K - 3000K 4K - 4000K
		AG - aluminium grey	
		VE - green	

### Lamp W Lm LED Real Lm Optic

LED	4	460	290	40°
-----	---	-----	-----	-----

Ottiche opzionali / Optional optics 12° (code + 12), 90° (code + 90)  
 Fornita con 1,5 m di cavo interrabile / 1,5 m buriabile cable included  
 Modulo LED a tensione di rete, compatibile con dimmer a taglio di fase /  
 Mains voltage LED module, compatible with most phase-cut dimmers  
 Versione RGBW (vedi capitolo dedicato) / RGBW version (see dedicated chapter)

**Su richiesta / On request**  
 2700K (code + 27K)  
 12-24V low voltage, cable L 20 cm (code + LV)  
 Lunghezza cavo 7 m / 7 m cable length (code + MT7)  
 ○ BI - white ● CO - corten ● GR - graphite ● GM - metallized grey

## CLOCK Ø 120 mm

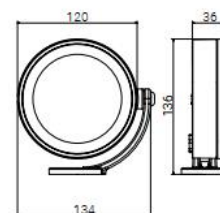

### Code

4664		AN - anthracite	3K - 3000K 4K - 4000K
		AG - aluminium grey	
4665		VE - green	

### Lamp W Lm LED Real Lm Optic

LED	10	1100	750	40°
	15	1575	1050	

Ottiche opzionali / Optional optics 12° (code + 12), 90° (code + 90)  
 Fornite con 1,5 m di cavo interrabile / 1,5 m buriabile cable included  
 Modulo LED a tensione di rete, compatibile con dimmer a taglio di fase /  
 Mains voltage LED module, compatible with most phase-cut dimmers  
 Versione RGBW (vedi capitolo dedicato) / RGBW version (see dedicated chapter)

**Su richiesta / On request**  
 2700K (code + 27K)  
 12-24V low voltage, cable L 20 cm  
 Lunghezza cavo 7 m / 7 m cable length (code + MT7)  
 Ottica a nido d'ape / Honeycomb optic 10° (code + HC)  
 ○ BI - white ● CO - corten ● GR - graphite ● GM - metallized grey



#### PICCHETTO / SPIKE



Code	Description	Ref. to
4691	Picchetto da giardino in policarbonato / Garden spike in polycarbonate	code 4661
		code 4664
		code 4665

Altezza da terra consigliata: 10 cm come da normativa / Recommended height above ground: 10 cm in compliance with regulations

Il cavo può passare nell'apposito foro della basetta e nella struttura del picchetto / The cable can pass through a special hole in the base and through the structure of the spike

#### VISIERA / SHIELD

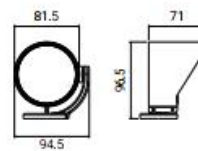

code 4668

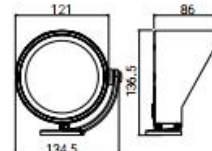

code 4669

Code	Description	Ref. to
4668	Visiera in acciaio inox verniciato / Shield in painted stainless steel	code 4661
4669		code 4664
		code 4665

# lichtmacher

Wir bringen Licht

„ Dunkelheit existiert nicht, nur die Abwesenheit von Licht. “



Dies ist nur ein kleiner Ausschnitt aus unserem Gesamtsortiment.  
Fragen Sie uns an.