

# lichtmacher

*Wir bringen Licht  
Aussenleuchten*



# Faro – LOTUS



## LOTUS

— Estudi Ribaudí



BOLLARDS

● 71224 dark grey/gris oscuro

LED COB 18W 3000K II 20lm CRI>80  
Driver ✓

Body Aluminium/Aluminio  
Diff Polycarbonate/Polycarbonato

IP65  IK08 100- 50/  
240V 60HZ 

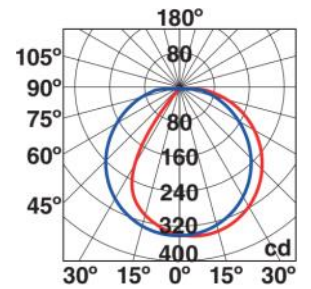
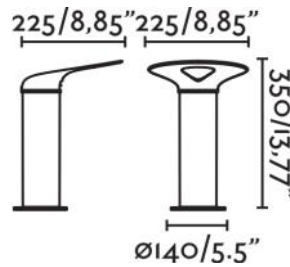

WALL

## LOTUS — Estudi Ribaudí



○ 71222 white/blanco

● 71223 dark grey/gris oscuro

LED 18W 3000K II 20lm CRI>80 Driver ✓

Body Aluminium/Aluminio  
Diff Polycarbonate/Polycarbonato

IP65  IK08 100- 50/  
240V 60HZ 

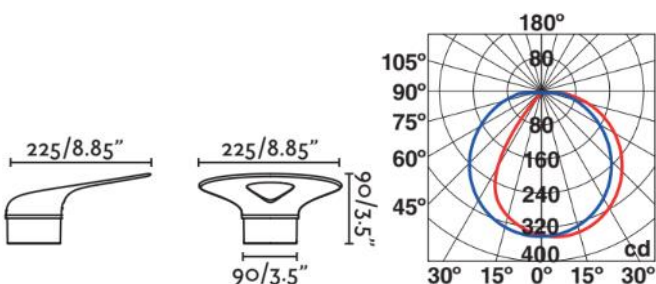

# BLOCK

— Àlex&Manel Llusca 



BOLLARDS

● 74141 grey/gris

E27 MAX 15W LED  [17463]

Body Concrete/Cemento  
Diff Opal Glass/Cristal Opal

**SEA SIDE SUITABLE** IP65  IK05 



● 74142 grey/gris

E27 MAX 15W LED  [17463]

Body Concrete/Cemento  
Diff Opal Glass/Cristal Opal

**SEA SIDE SUITABLE** IP65  IK05 

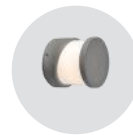
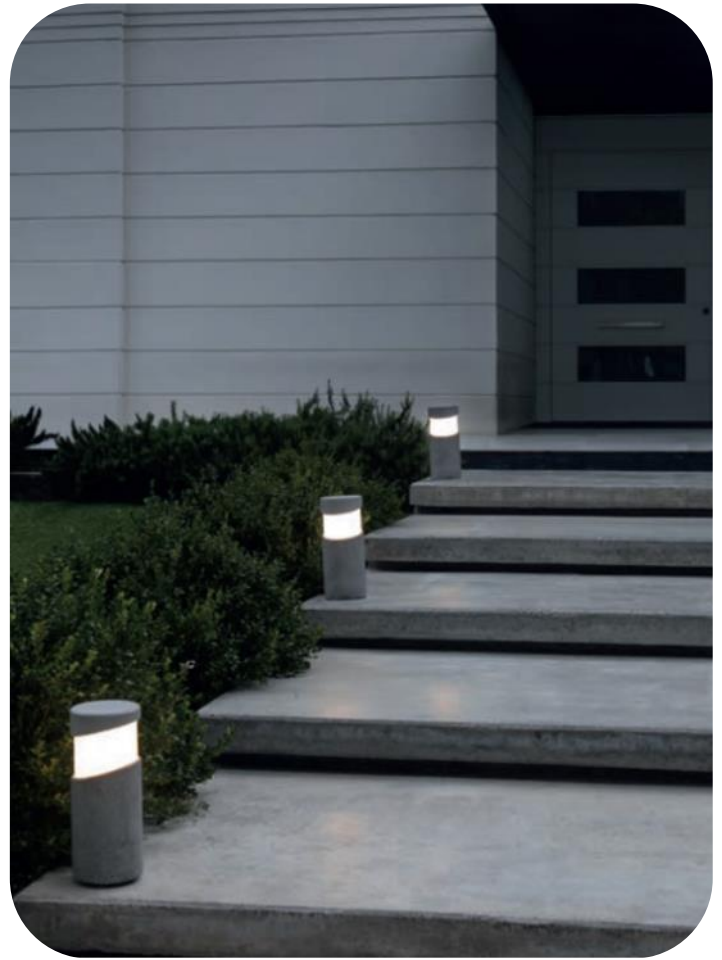
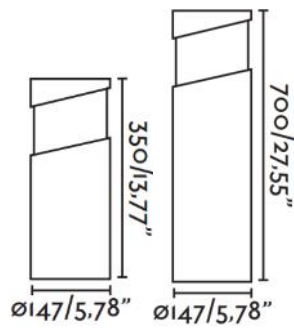

WALL

BLOCK — Àlex&Manel Llusca 

● 74139 grey/gris

E27 MAX 15W LED  [17463]

Body Concrete/Cemento  
Diff Opal Glass/Cristal Opal

IP65  IK05 **SEA SIDE SUITABLE** 

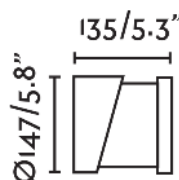

# Faro – HALF



## HALF — Nahtrang

● **71537** dark grey/gris oscuro

**LED** SMD 20W **3000K** | 350lm CRI>80

Driver 

Body Die Cast Aluminium/Aluminio Inyectado  
Diff Opal Glass/Cristal Opal

**IP65**  100- 50/  
240V 60HZ 

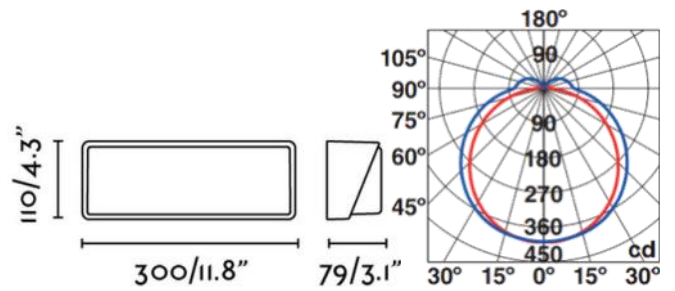

## Kila

- 71743   Dark Grey/Gris Oscuro + Transparent/Transparente
- 71744   Dark Grey/Gris Oscuro + Smoked/Fumé
- 71745   Dark Grey/Gris Oscuro + Amber/Ámbar

**Material** Body Aluminium/Aluminio  
Diff Transparent Glass/Cristal Transparente

**Light Source** 1 E27 max. 15W

**Bulb incl.** No

**Recom. Bulb** 17463

**Class** I

**IP** 65



## Faro – Kila

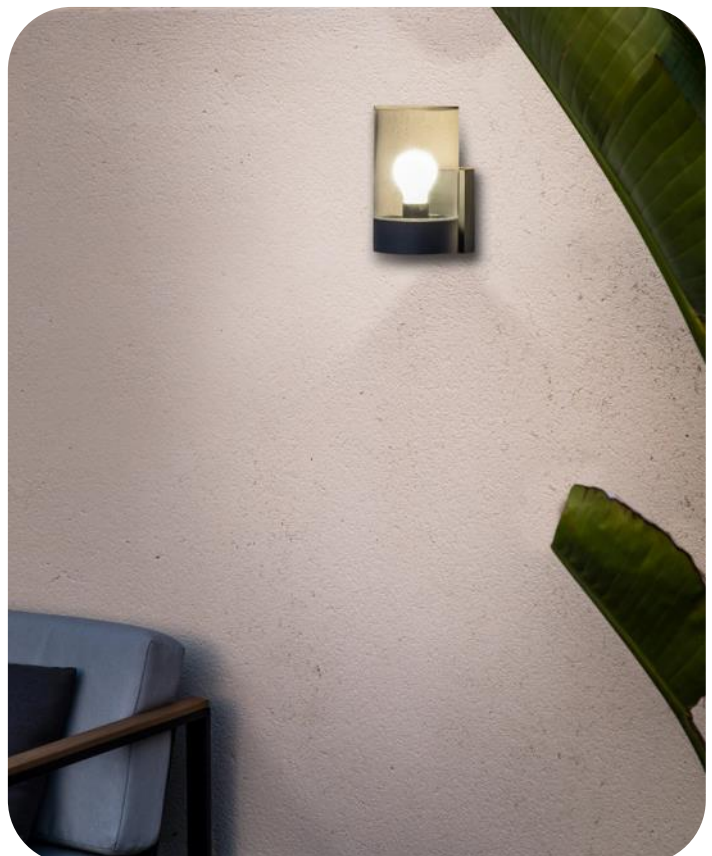



**LAKO NEW**

- 71909 matt white/blanco mate
- 71910 dark grey/gris oscuro
- 71911 brown/marrón

LED SMD 8W 3000K 600lm CRI>80 Driver ✓

**Body** Aluminium/Aluminio  
**Diff** Transparent Glass/Cristal Transparente

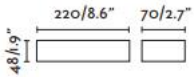

**DORO NEW**

- 71903 matt white/blanco mate
- 71904 dark grey/gris oscuro
- 71905 brown/marrón

LED SMD 20W 3000K 1800lm CRI>80 Driver ✓

**Body** Aluminium/Aluminio  
**Diff** Transparent Glass/Cristal Transparente

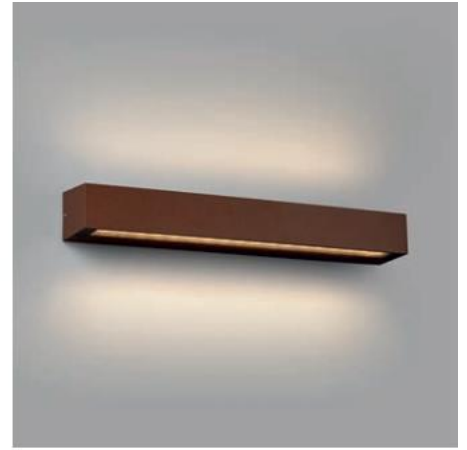
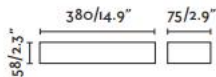
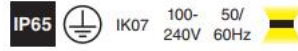

**DORO NEW**

- 71906 matt white/blanco mate
- 71907 dark grey/gris oscuro
- 71908 brown/marrón

LED SMD 28W 3000K 2350lm CRI>80 Driver ✓

**Body** Aluminium/Aluminio  
**Diff** Transparent Glass/Cristal Transparente

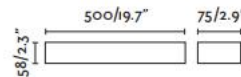

**DORO NEW**

- 71900 matt white/blanco mate
- 71901 dark grey/gris oscuro
- 71902 brown/marrón

LED SMD 13W 3000K 1000lm CRI>80 Driver ✓

**Body** Aluminium/Aluminio  
**Diff** Transparent Glass/Cristal Transparente

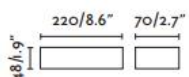

Faro – LAKO, DORO

# SPUTNIK



**1 DL 7-665**  
**Schwarz**  
EE3  
Ø 14,5 cm, H 12 cm  
LED 13 W/1030 lm/3000 K  
Schutzglas mattiert/frosted glass  
IP65

**2 DL 7-665**  
**Weiß**  
EE3  
Ø 14,5 cm, H 12 cm  
LED 13 W/1030 lm/3000 K  
Schutzglas mattiert/frosted glass  
IP65



**1 GRETA**

EE3 AL 11-1206

**Anthrazit**

B 14 cm, H 10 cm, T 12 cm  
LED 13W/700lm/3000K  
Aluguss/die-cast aluminium  
IP54

**2 CUBE**

EE3 AL 11-1192

**Alu**

L 10 cm, B 10 cm, T 10 cm  
LED 2x3 W/400 lm/3000 K  
Aluguss/die-cast aluminium  
IP54

**3 CUBE**

EE3 AL 11-1192

**Weiß**

L 10 cm, B 10 cm, T 10 cm  
LED 2x3 W/400 lm/3000 K  
Aluguss/die-cast aluminium  
IP54

**4 CUBE**

EE3 AL 11-1192

**Anthrazit**

L 10 cm, B 10 cm, T 10 cm  
LED 2x3 W/400 lm/3000 K  
Aluguss/die-cast aluminium  
IP54



# SPIKE, AKZENT, MOOD, ASTRA

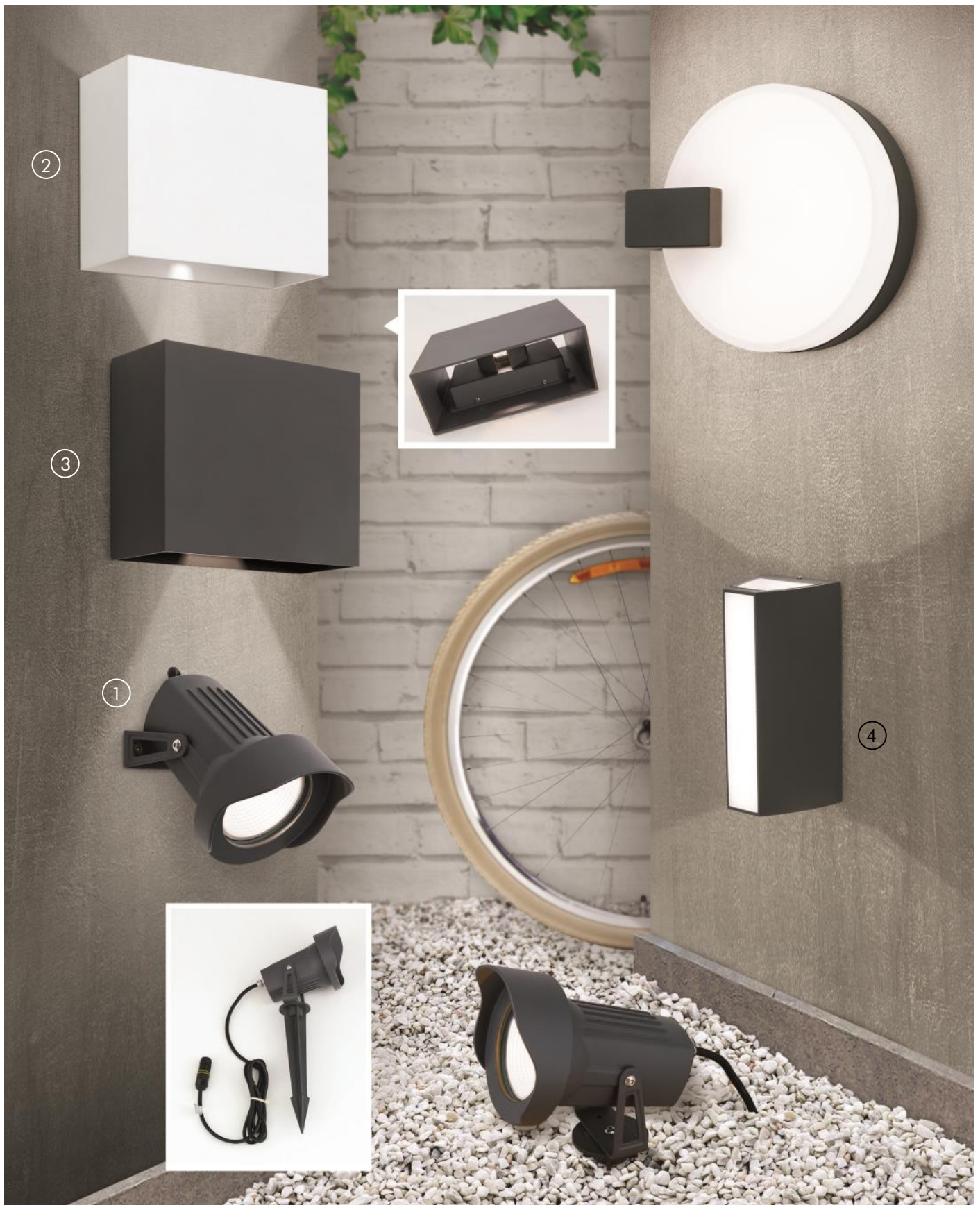

## 1 SPIKE

EE3 AL 11-1201

**Anthrazit**

Ø 11,5 cm, L 17 cm, Ausl. 45 cm  
LED 8 W/550 lm/3000 K  
inkl. Erdspeiß und IP68 Anschluss/  
incl. spike and IP68 connector  
2 m Kabel/wire  
IP65

## 2 AKZENT

EE3 AL 11-1202

**Weiß**

18 x 15 cm, T 7,4 cm  
LED 2x6 W/580 lm/3000 K  
Abstrahlwinkel einstellbar/  
light angle adjustable  
IP65

## 3 AKZENT

EE3 AL 11-1202

**Anthrazit**

18 x 15 cm, T 7,4 cm  
LED 2x6 W/580 lm/3000 K  
Abstrahlwinkel einstellbar/  
light angle adjustable  
IP65

## 4 MOOD

EE3 AL 11-1203

**Anthrazit**

H 15,5 cm, B 6,5 cm  
T 6,5 cm  
LED 4 W/225 lm  
3000 K  
IP65



# HENDRYK & GINGER



2

1

3



1

**AL 11-1210**  
**Anthrazit**  
 B 21,2 cm, H 10 cm, A 16,7 cm  
 LED 21 W/1800 lm/2700 K  
 mit Sensor (Zeit und Helligkeit)/  
 with sensor (TIME and LUX)  
 IP54

2

**AL 11-1211**  
**Anthrazit/Sensor**  
 B 12,3 cm, H 16 cm, Ausl. 20,6 cm  
 LED 21 W/1800 lm/2700 K  
 mit Sensor (Zeit und Helligkeit)/  
 with sensor (time and lux)  
 IP54

3

**AL 11-1211**  
**Weiß/Sensor**  
 B 12,3 cm, H 16 cm, Ausl. 20,6 cm  
 LED 21 W/1800 lm/2700 K  
 mit Sensor (Zeit und Helligkeit)/  
 with sensor (time and lux)  
 IP54



# GINA

● 71352 dark grey/gris oscuro

GU 10 MAX 8W LED ☒ [17324]

Body Die Cast Aluminium/Aluminio Inyectado  
Diff Transparent Glass/Cristal Transparente



BOLLARDS

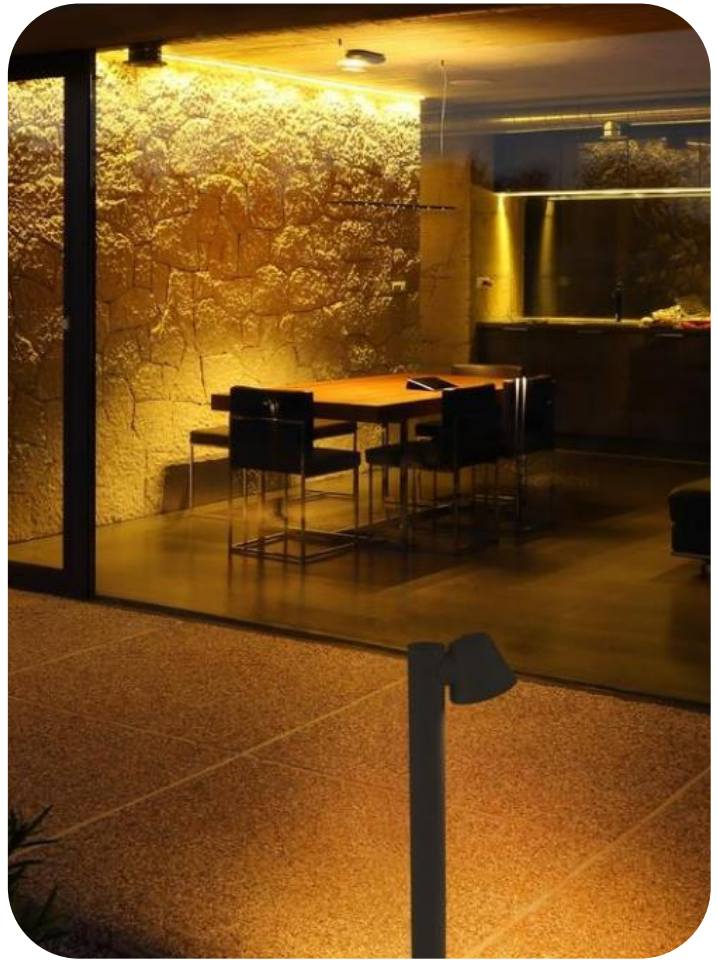
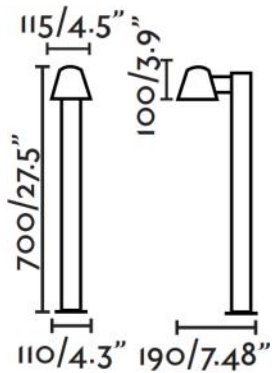

WALL

# GINA

● 71363 dark grey/gris oscuro

○ 71366 white/blanco

● 71367 black/negro

GU 10 MAX 8W LED ☒ [17324]

Body Die Cast Aluminium/Aluminio Inyectado  
Diff Glass/Cristal

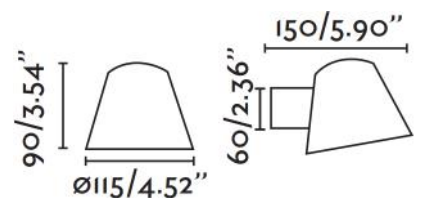

# Faro – Path

## Path

70501

● Matt White/Blanco Mate

70508

● Dark Grey/Gris Oscuro

### Material

**Body** Aluminium/Aluminio

**Diff** Transparent PC/PC Transparente

### Light Source

SMD LED 9W 3000K 390Lm

### CRI

>80

### Driver incl.

Yes

### Class

I

### Voltage (V/Hz)

100V-240V/50-60HZ

### IP

44

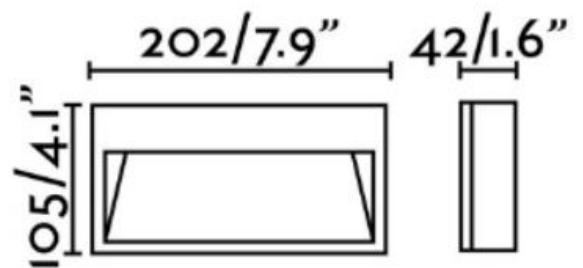

# ADAY

- 70646 white/blanco
- 70647 dark grey/gris oscuro

BOLLARDS

LED SMD 13W 3000K 787lm CRI>80 Driver ✓

Body Die Cast Aluminium/Aluminio Inyectado  
Diff Opal Polycarbonate/Polycarbonato Opal

IP54 IK08  220-240V 50/60HZ 

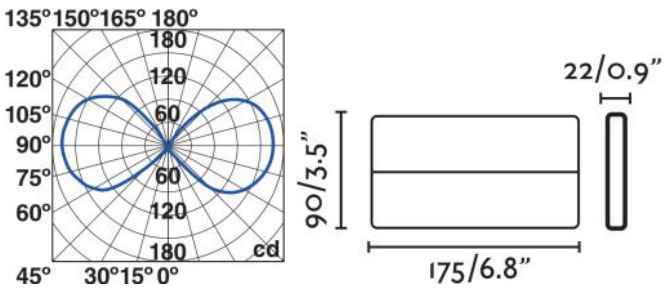

# Faro – LACE





# LACE

- 70811 dark grey/gris oscuro

LED HIGH POWER 6W 4000K 315lm CRI>80 Driver ✓

Body Die Cast Aluminium/Aluminio Inyectado  
Diff Transparent Glass/Cristal Transparente

IP54  100-240V 50/60HZ  110°

WALL

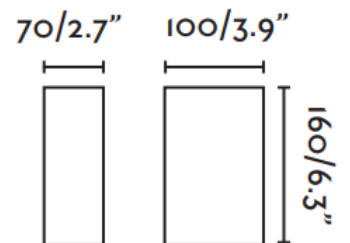

# LEO

## Decorative Bulkhead



Art. Nc 4027-DG 1x E27 Dunkelgrau

Art. Nc 4027-HG 1x E27 Hellgrau

Eine Aussenleuchte IP54-LED-Oberflächenleuchte mit opalem Diffusor und dekorativen indirekten Wandlichteffekten.

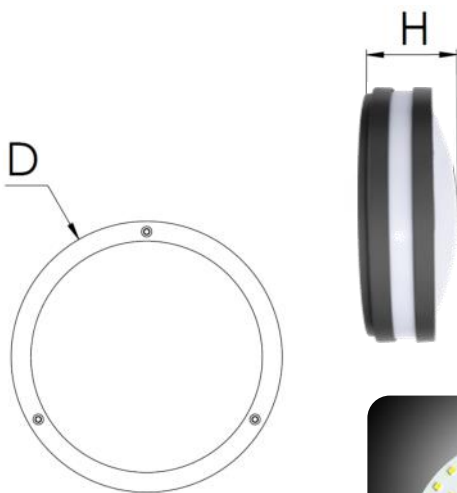

D, mm	H, mm
265	90
	100

### Umrüstsatz von E27 auf LED

**Diffusor:** opales Polycarbonat, UV-stabil, schlagfest

**Gehäuse:** Aluminium-Druckguss

**Farben:** Dunkelgrau RAL 7043 & Aluminium RAL 7004

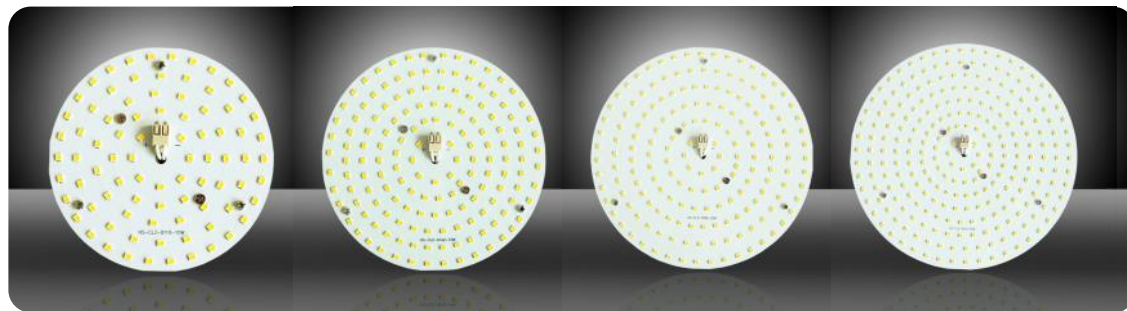

LED Einbauleuchte	E4027-1030/40	E4027-1530/40	E4027-2030/40	E4027-2530/40
Leistung	10W	15W	20W	25W
Lumen	85lm/w CRI>80			
Lichtfarbe	3000/4000K	3000/4000K	3000/4000K	3000/4000K

# LED AP Leuchte



WW = 3000k  
 NW = 4000K  
 CW = 6000K

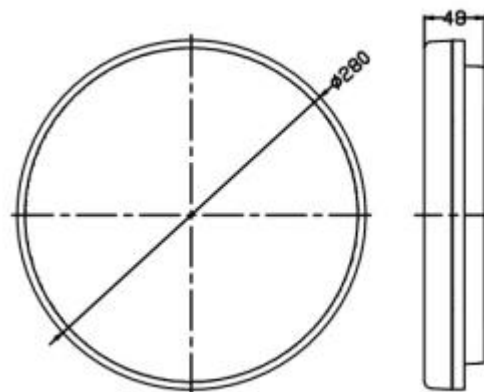
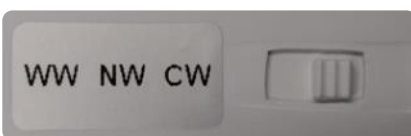

220  
240 V~



Artikel Nr.	Produktbeschreibung	Systemleistung (W)	Lichtstrom (lm)	Farbtemperatur (k)
bl 18-rc	LED AP Leuchte nicht dim IP54	18w	1980lm	3000/4000/6000k
bl 18-rcd	LED AP Leuchte dim IP54 Phasenschnitt	18w	1980lm	3000/4000/6000k
bl 18-rcs	LED AP Leuchte Sensor IP54	18w	1980lm	3000/4000/6000k
bl 18-rce	LED AP Leuchte nicht dim Notlicht 3h IP40	18w	1980lm	3000/4000/6000k

# BL 19



## Technische Daten:

Power	18W
Eingangsspannung	AC230V
Lichtfarbe	3000/4000/6000k
Farbwiedergabe	Ra80
Lumen	1980lm
Ausstrahlungswinkel	120°
Dimmbar	Nein
IK Stufe	IK08
Lebensdauer	45000 Stunden

Artikel Nr.      Produktbeschreibung

bl 19-rc              LED AP Leuchte  
nicht dim IP54

bl 19-rcs            LED AP Leuchte Sensor  
IP54

bl 19-rce            LED AP Leuchte nicht  
dim Notlicht 3h IP40

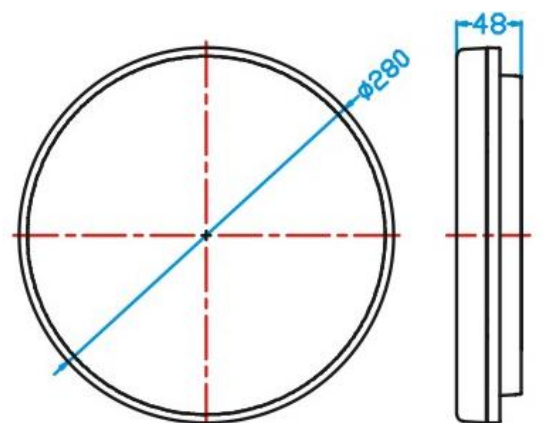

REA



REA

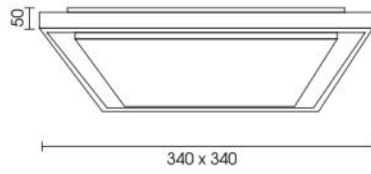

REA

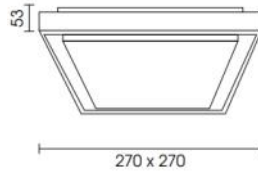

Art. Nr. / item nr.	Name / name	Daten / information
AL8028-34-19	REA	LED · 30W · 3.000lm
AL8028-27-19		LED · 25W · 2.500lm



19 Materialfarben  
material colours







DARDO

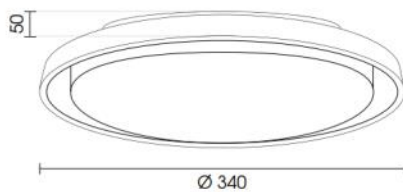

DARDO

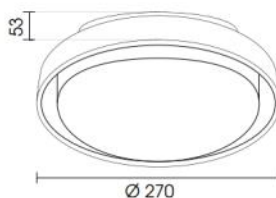



Art. Nr. / item nr.	Name / name	Daten / information
AL8027-34-19	DARDO	LED · 30W · 3.000lm
AL8027-27-19		LED · 25W · 2.500lm



# Goccia - Kyklo

**goccia**  
ILLUMINAZIONE



Code				
1241	 AN - anthracite	3K - 3000K 4K - 4000K		
	 AG - aluminium grey			
	 BI - white			
Lamp	W	Lm LED	Real Lm	Optic
LED	10	1100	750	40°

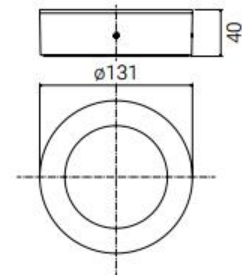

Code					Lamp	W	Lm LED	Real Lm	Optic
1242	 AN - anthracite	3K - 3000K 4K - 4000K			LED	10	1100	363	diffuse
	 AG - aluminium grey								
	 BI - white								



## SLV – ARROCK STONE



### Produktangaben

100-240V ~50/60Hz | 700mA  
 Systemleistung: 9W  
 Material: Basalt / Edelstahl 304

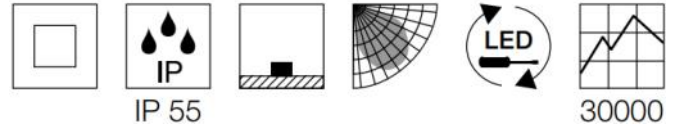

Variante	Art. Nr.
330lm   3000K   CRI>80   H: 50 cm   15,5 kg ■ grau	<b>231370</b>
330lm   3000K   CRI>80   H: 75 cm   22,2 kg ■ grau	<b>231371</b>

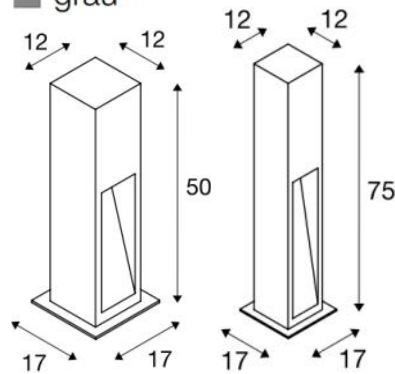

## SLV – ARROCK SLOT

### Produktangaben

230V ~50Hz  
 Material: Granit / Edelstahl 304

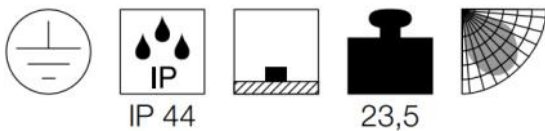

Variante	Art. Nr.
GU10   LED GU10 51mm ■ grau / chrom	<b>231440</b>

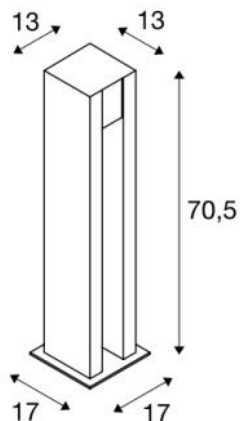

**Produktangaben**

220-240V ~50/60Hz  
 Systemleistung: 8W  
 Material: Aluminium  
 Dimmbar: Triac L

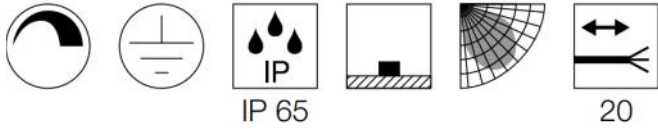
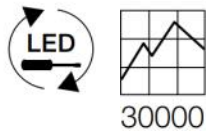

Variante	Art. Nr.
440lm   3000K   CRI>80   H: 90 cm   1,466 kg ■ anthrazit	<b>1000682</b>
440lm   3000K   CRI>80   H: 120 cm   1,845 kg ■ anthrazit	<b>1000683</b>

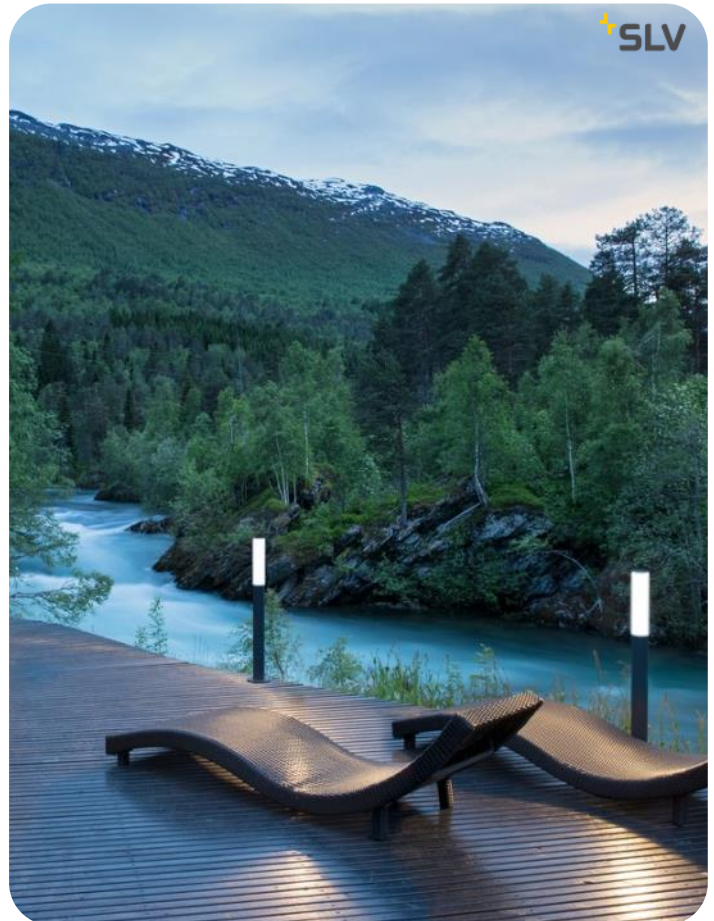
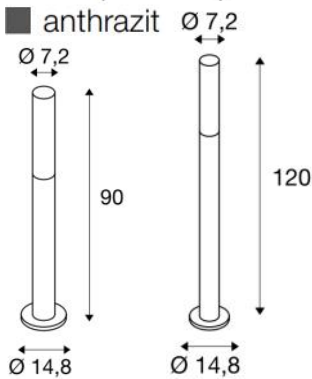

**SLV – QUADRASYL 75**



**Produktangaben**

100-240V ~50/60Hz | 700mA  
 Systemleistung: 9W  
 Material: Basalt / Edelstahl 304

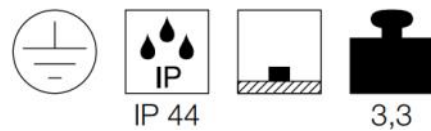

Variante	Art. Nr.
GX53   TCR-TSE ■ grau	<b>232294</b>
GX53   TCR-TSE ■ anthrazit	<b>232295</b>

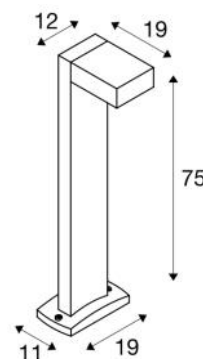

## SLV – RUSTY SLOT 50/80 E27

### Produktangaben

230V ~50Hz

Material: FeCSi-Stahl / Polycarbonat (PC)

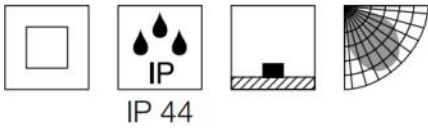

IP 44

Variante	Art. Nr.
----------	----------

E27 | H: 50 cm | 12,5 kg

■ rost **229410**

E27 | H: 80 cm | 18,5 kg

■ rost **229411**

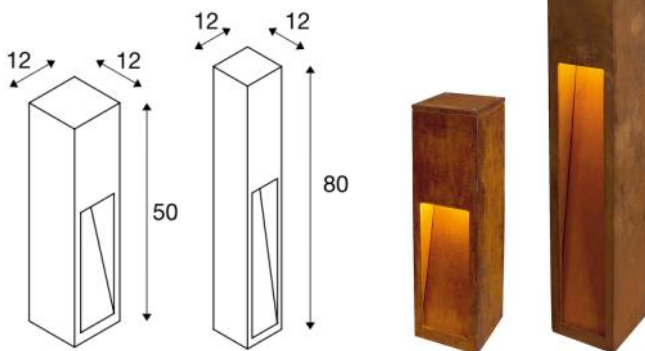

## SLV – RUSTY SLOT 50/80



### Produktangaben

220-240V ~50/60Hz

Systemleistung: 8,6W

Material: FeCSi-Stahl / Polycarbonat (PC)

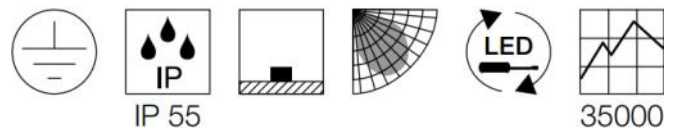

IP 55

35000

Variante	Art. Nr.
----------	----------

30lm | 3000K | CRI>80 | H: 50 cm | 12,5 kg

■ rost **233447**

30lm | 3000K | CRI>80 | H: 80 cm | 18,5 kg

■ rost **233457**

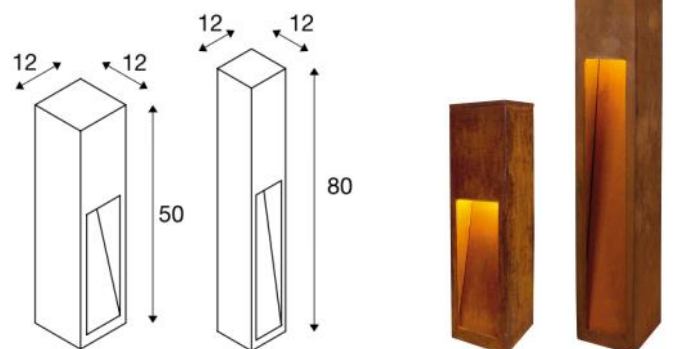



## Klassische Pollerleuchte neu interpretiert

### START Bollard IP65

Die neue START Bollard IP65 Serie ist eine moderne Version des Pollers im klassischen Stil. Sie eignet sich ideal für die Beleuchtung von Außenbereichen wie Gärten, Parks und Wegen sowie im gewerblichen Sektor. Darüber hinaus kann die Start Bollard IP65 auch in Küstengebieten eingesetzt werden. Die Poller sind in 0,5 und 1m Höhe erhältlich und entsprechen den Anforderungen an IK10.



# START Bollard IP65



## Produkteigenschaften

- Modern gestaltete Pollerleuchte
- Ideal für die Beleuchtung von Außenbereichen wie Gärten, Parks und Wegen sowie im gewerblichen Sektor geeignet
- Auch in Küstengegenden einsetzbar
- Robustes Design entspricht Anforderungen an IK10
- In zwei Größen erhältlich: 500mm & 1.000mm
- Umgebungstemperaturen: -35°C bis +50°C
- Hohe Leistung: Leuchtenlichtstrom von bis zu 1.100lm bei einer Systemeffizienz von bis zu 42lm/W
- In Warmweiß (3.000K) und Neutralweiß (4.000K) erhältlich
- Energieeffizienzklassen A++ A+ A
- Lebensdauer: 50.000 Stunden

## Produktinformationen

Art.-Nr.	Beschreibung	Treiber	Gehäusefarbe	Höhe (m)	Lichtfarbe	Farbtemperatur (K)	Spannung (V)	Stromstärke (mA)	Systemleistung (W)	Leuchtenlichtstrom (lm)	Systemeffizienz (lm/W)	Lebensdauer (Stunden)	Gewicht (kg)
<b>Start Bollard IP65</b>													
0047940	START Bollard M IP65 26W 1100lm 830 schwarz	Electronic	RAL9005	0,5	Warmweiß	3000	220-240	1200	26	1100	42	50.000	5,5
0047941	START Bollard L IP65 26W 1100lm 830 schwarz	Electronic	RAL9005	1	Warmweiß	3000	220-240	1200	26	1100	42	50.000	6,5
0047942	START Bollard M IP65 26W 1100lm 840 schwarz	Electronic	RAL9005	0,5	Warmweiß	4000	220-240	1200	26	1100	42	50.000	5,5
0047943	START Bollard L IP65 26W 1100lm 840 schwarz	Electronic	RAL9005	1	Warmweiß	4000	220-240	1200	26	1100	42	50.000	6,5

## Photometrische Daten

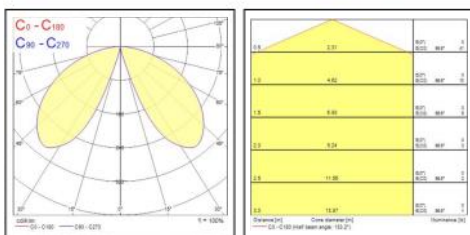

START Bollard M IP65 26W 1100lm 830 schwarz

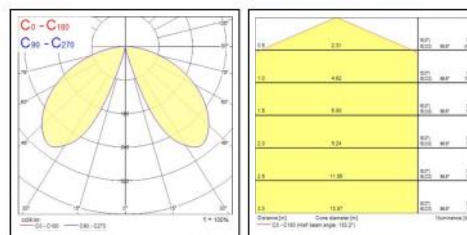

START Bollard L IP65 26W 1100lm 830 schwarz

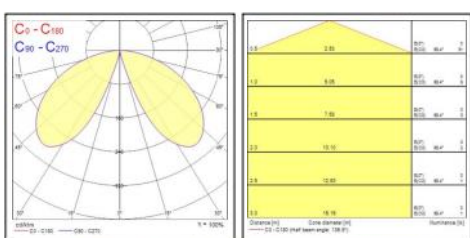

START Bollard M IP65 26W 1100lm 840 schwarz

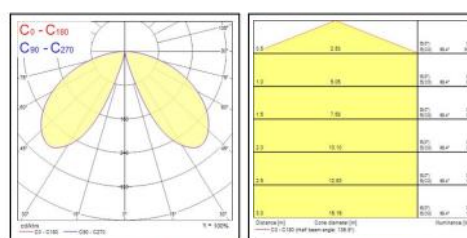

START Bollard L IP65 26W 1100lm 840 schwarz

## Abmessungen (mm)

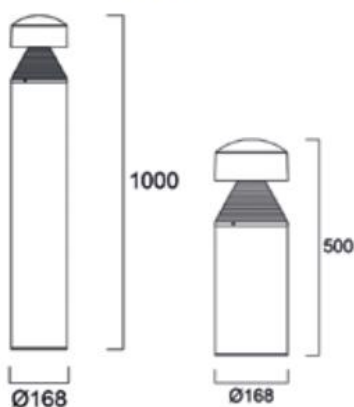

## Weitere Produktabbildungen



# lichtmacher

Wir bringen Licht

„ Dunkelheit existiert nicht, nur die Abwesenheit von Licht. “



Dies ist nur ein kleiner Ausschnitt aus unserem Gesamtsortiment.  
Fragen Sie uns an.