

lichtmacher



Wir bringen Licht

1 Phasenschienensystem





iO 48V_186

iO SURFACE_262

iO RECESSED PROFILE_326

EXTENDED FAMILY





	P	CCT	Beam	I	Flux	LOR
i0 A262-00-10- WT NT	4,5W	2700K	20°	500mA	485Lm	92%
A262-00-11- WT NT	4,5W	3000K	20°	500mA	505Lm	92%
A262-00-12- WT NT	4,5W	4000K	20°	500mA	520Lm	92%
A262-00-20- WT NT	4,5W	2700K	30°	500mA	485Lm	89%
A262-00-21- WT NT	4,5W	3000K	30°	500mA	505Lm	89%
A262-00-22- WT NT	4,5W	4000K	30°	500mA	520Lm	89%
A262-00-30- WT NT	4,5W	2700K	56°	500mA	485Lm	86%
A262-00-31- WT NT	4,5W	3000K	56°	500mA	505Lm	86%
A262-00-32- WT NT	4,5W	4000K	56°	500mA	520Lm	86%

LED | 220-240 V~ | CE | IP20 | CRI>90 | L80B10 >60.000 h



ACCESSORIES

NOT SOLD SEPARATELY

i0 High Chromatic LED*



i » 366

i0 Beam Mixer Diffuser*

0805-01-00



i0 Anti-glare Honeycomb Louver*

0806-00-00 | WT | NT |



i0

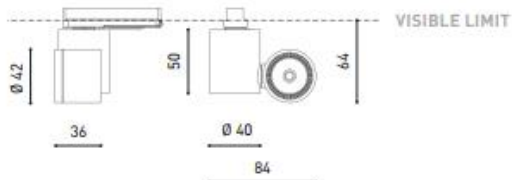

COLOUR | WT □ RAL 9016 | NT ■ RAL 9005 |

MATERIAL | AL | PC |

TRACK 1L i » 208

* AFFECTS THE LIGHTING PARAMETERS

» PLEASE CONSULT

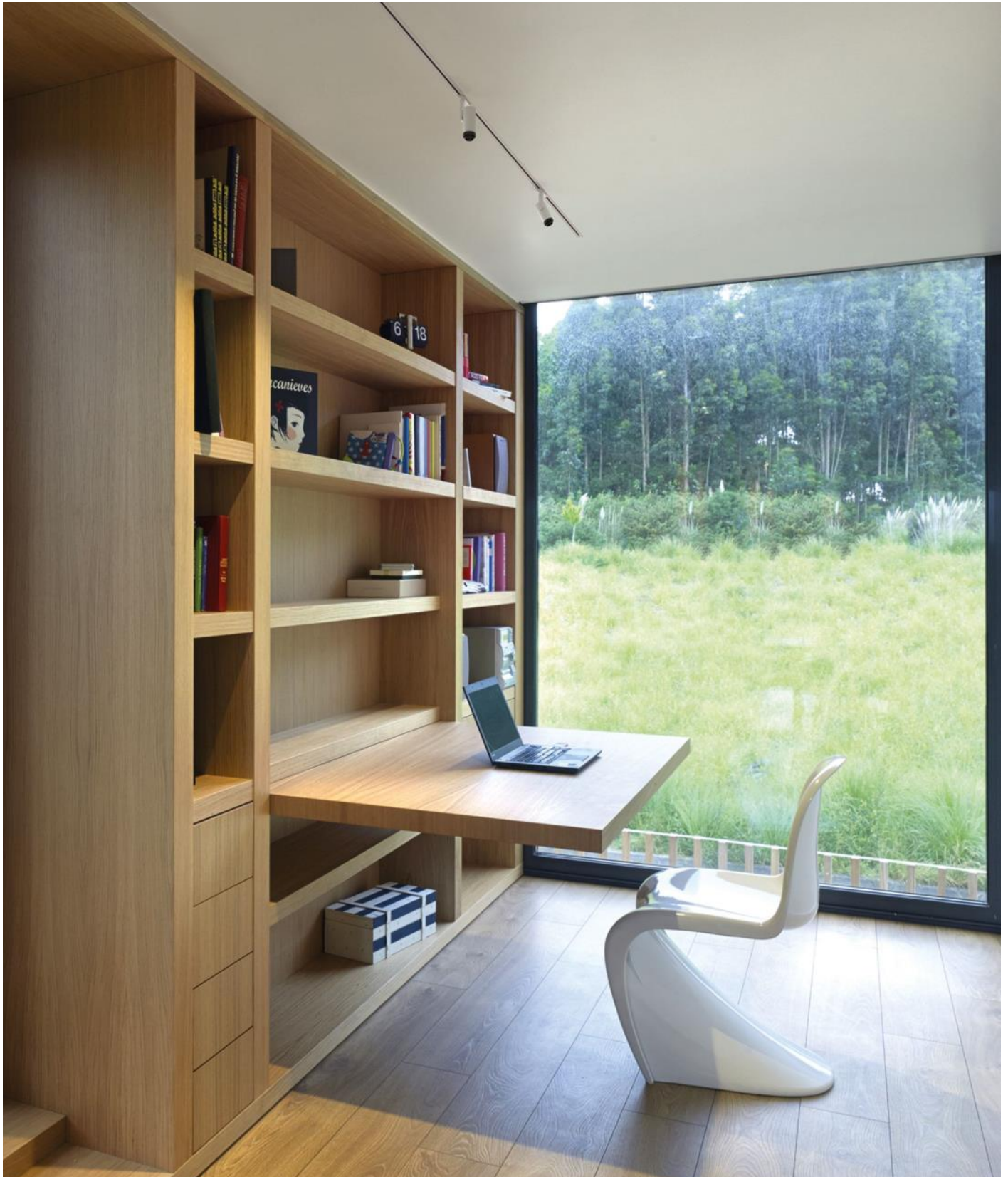

EXTENDED FAMILY

PLUS RECESSED_162

PLUS 48V_182

PLUS_218

PLUS MINI 1L



		P	CCT	Beam	I	Flux	LOR
PLUS Mini 1L	A327-00-20- WT NT	4,5W	2700K	10°-41°	500mA	480Lm	20-40%
	A327-00-21- WT NT	4,5W	3000K	10°-41°	500mA	500Lm	20-40%
	A327-00-22- WT NT	4,5W	4000K	10°-41°	500mA	515Lm	20-40%

LED | 220 V~ | CE | IP20 | CRI>90 | L80B10 >60.000h



ACCESSORY

PLUS MINI High Chromatic LED**

NOT SOLD SEPARATELY

LED ⓘ » 366



ⓘ » 164

PLUS MINI 1L

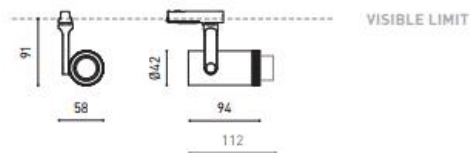

COLOUR | WT □ RAL 9016 | NT ■ RAL 9005 | MATERIAL | AL | OPTICAL PMMA | TRACK 1L ⓘ » 208

** ACCESSORY AFFECTS THE LIGHTING PARAMETERS



EXTENDED FAMILY

FIT RECESSED_160
FIT 48V_174

FIT



>> MORE INFO

		P	CCT	Beam	I	Flux	LOR
FIT 65 1L	A366-01-11- WT NT	10,3W	3000K	18°	300mA	1300 lm	90%
	A366-01-12- WT NT	10,3W	4000K	18°	300mA	1320 lm	90%
	A366-01-21- WT NT	10,3W	3000K	26°	300mA	1300 lm	88%
	A366-01-22- WT NT	10,3W	4000K	26°	300mA	1320 lm	88%
	A366-01-31- WT NT	10,3W	3000K	36°	300mA	1300 lm	84%
	A366-01-32- WT NT	10,3W	4000K	36°	300mA	1320 lm	84%

220
240 V~ | IP20 | CRI>90 | L80B10
>60.000h



OPTIONAL ACCESSORY

FIT 65 Anti-glare Honeycomb Louver * A356-00-00

NOT SOLD SEPARATELY

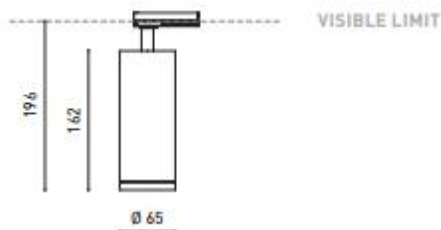

COLOUR | WT | NT |

MATERIAL | AL | PC |

TRACK 1L » 414

* ACCESSORY AFFECTS THE LIGHTING PARAMETERS

SURFACE & SUSPENDED

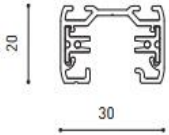
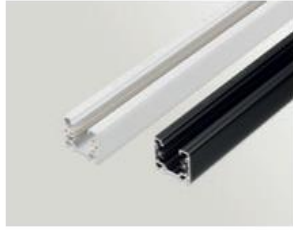

TRACK 1L 1m	A264-01-00- B N
TRACK 1L 2m	A264-02-00- B N
TRACK 1L 3m	A264-03-00- B N



POLARITY GROOVE



TRACK 1L Live-End Connector
A264-00-01- B N
A264-00-02- B N



TRACK 1L Contact Joint
A264-00-04- B N

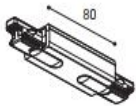

TRACK 1L Central Connector
A264-00-03- B N



TRACK 1L End
A264-00-13- B N

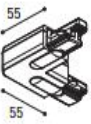

TRACK 1L 90° Angle
A264-00-06- B N
A264-00-07- B N

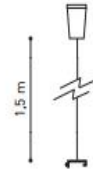

TRACK 1L Suspension Kit
A264-00-14- WT NT
At least 2 units needed



TRACK 1L Corner connector
A264-00-15- B N

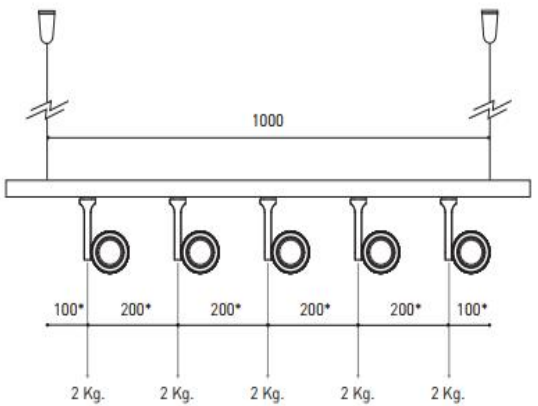

*minimum distance [mm.]

TRACK 1L

FLUSH MOUNTING

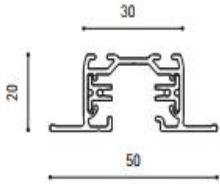
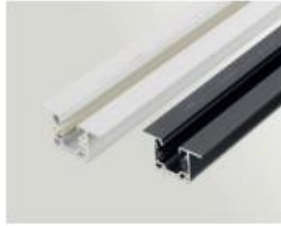

TRACK 1L FLUSH 1m	A264-11-00- B N
TRACK 1L FLUSH 2m	A264-12-00- B N
TRACK 1L FLUSH 3m	A264-13-00- B N



POLARITY GROOVE

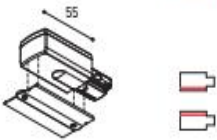

TRACK 1L FLUSH Live-End Connector
A264-00-01- B N
A264-00-02- B N



TRACK 1L Contact Joint
A264-00-04- B N

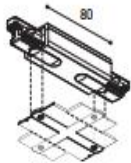

TRACK 1L FLUSH Cover Plate
A264-10-19- B N
Mandatory for installation



TRACK 1L End
A264-00-13- B N

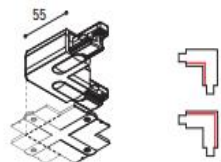

TRACK 1L FLUSH Central Connector
A264-00-03- B N

TRACK 1L FLUSH Corner Cover Plate
A264-10-20- B N
Mandatory for installation



TRACK 1L FLUSH Suspension Kit
A264-10-15

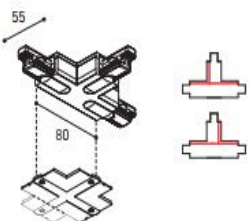

TRACK 1L FLUSH 90° Angle
A264-00-06- B N
A264-00-07- B N

TRACK 1L FLUSH Corner Cover Plate
A264-10-20- B N
Mandatory for installation

TRACK 1L FLUSH T-Joint
A264-00-16- B N
A264-00-17- B N

TRACK 1L FLUSH Corner Cover Plate
A264-10-20- B N
Mandatory for installation

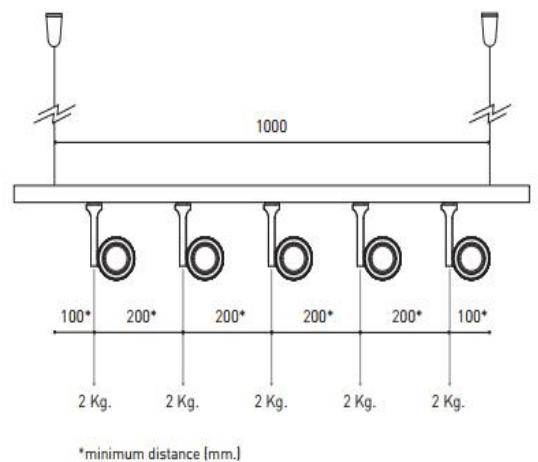

COLOUR | B □ RAL 9016 | N ■ RAL 9005 | WT □ RAL 9016 | NT ■ RAL 9005 |

i » 368

RECOMMENDED FOR INSTALLATIONS WHERE THE PROFILE CAN BE INSTALLED BEFORE THE FALSE PLASTERBOARD CEILING (THICKNESS 12,5mm.)

Panel Track
eckig



Panel Track
rund

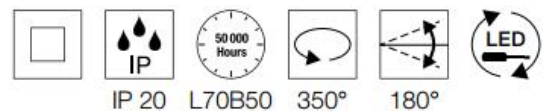
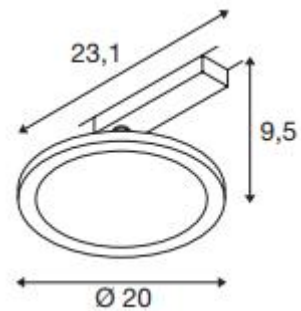
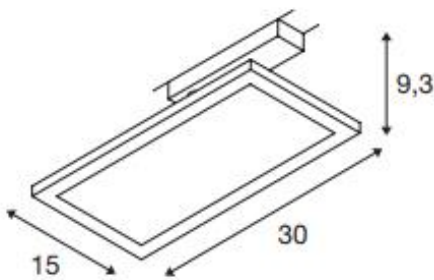
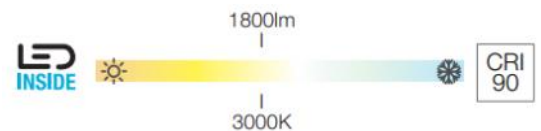
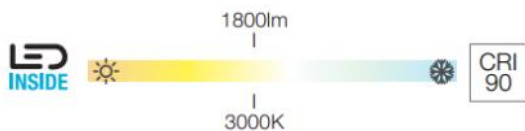

220-240V ~50/60Hz | 450mA
Systemleistung: 18W
Material: Polycarbonat (PC) / Stahl

220-240V ~50/60Hz | 450mA
Systemleistung: 18W
Material: Polycarbonat (PC) / Stahl

1004933, 1004934	1800lm 3000K	

1004935, 1004936	1800lm 3000K	

Variante	Art. Nr.
1800lm 3000K CRI90	
■ schwarz	1004933
1800lm 3000K CRI90	
weiß	1004934

Variante	Art. Nr.
1800lm 3000K CRI90	
■ schwarz	1004935
1800lm 3000K CRI90	
weiß	1004936



Para Cone GL

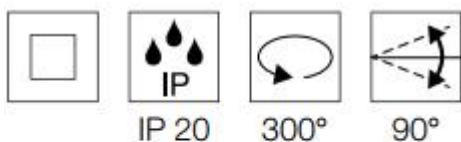
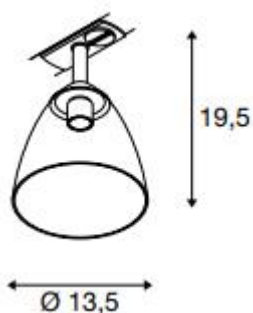

220-240V ~50/60Hz
Material: Aluminium / Glas

LED GU10 | 3,2W
2700K | 270lm | EEK=G
4kWh/1000h

Art. Nr. 1006321



Variante	Art. Nr.
1xGU10	
■ schwarz	1006155
1xGU10	
weiß	1006156

Para Cone GL

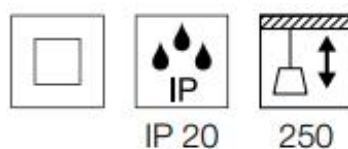
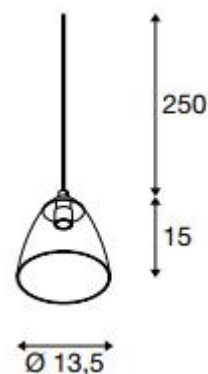

220-240V ~50/60Hz
Material: Aluminium / Glas

LED GU10 | 3,2W
2700K | 270lm | EEK=G
4kWh/1000h

Art. Nr. 1006321



Variante	Art. Nr.
1xGU10	
■ schwarz	1006159
1xGU10	
weiß	1006160

1-Phasen Leuchtenadapter

6A max. | Polycarbonat (PC)
L: 8,2 cm B: 3,5 cm H: 4,2 cm

■ schwarz	Art. Nr. 143120
weiß	143121
■ grau	143124

Para Cone 14

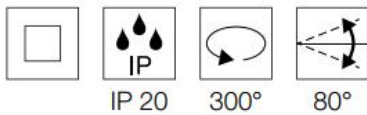
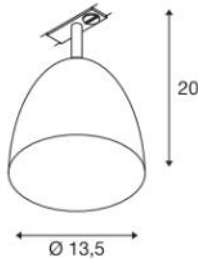

220-240V ~50/60Hz
Material: Stahl

LED GU10 | 3,2W
2700K | 270lm | EEK=G
4kWh/1000h

Art. Nr. 1006321



Para Cone 14

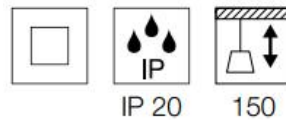
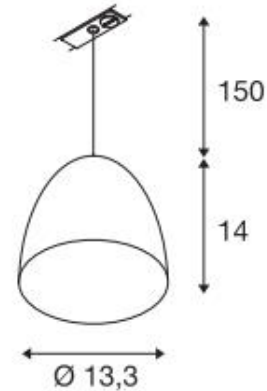

230V ~50Hz
Material: Stahl

- Textilkabel
- schwarz/gold Version mit goldenem Reflektor
- Alle anderen Version mit weißem Reflektor

LED GU10 | 3,2W
2700K | 270lm | EEK=G
4kWh/1000h

Art. Nr. 1006321



Variante	Art. Nr.
1xGU10	
■ glänzend schwarz	1002873
1xGU10	
glänzend weiß	1002874
1xGU10	
■ kupfer	1002875

SLV

Variante	Art. Nr.
1xGU10	
■ glänzend schwarz	143990
1xGU10	
glänzend weiß	143991
1xGU10	
■ kupfer	1001968

Tonga

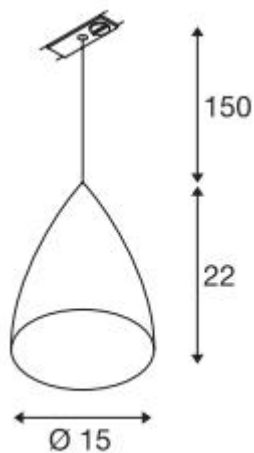

SOCKET INSIDE



<60
W



IP 20

150

220-240V ~50/60Hz
Material: Aluminium / Glas

LED E14 | 4,2W | 320°
2700K | 370lm | EEK=F
4kWh/1000h

Art. Nr. 1005284



SLV

Variante	Art. Nr.
1xE14 grau / milchig	143594



Ligth Eye 90

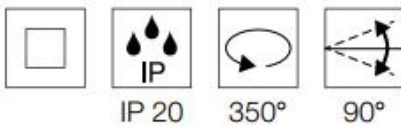
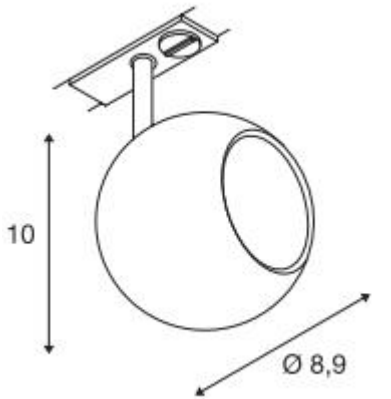

230V ~50/60Hz
Material: Stahl

LED GU10 51mm | 4W | 36°
2700K | 270lm | EEK=G
4kWh/1000h

Art. Nr. 1004972



- Leuchtmittel Dekoring Ø 5,7 cm
Art. Nr. 151040
- Leuchtmittel Dekoring Ø 5,7 cm
Art. Nr. 151041
- Leuchtmittel Dekoring Ø 5,7 cm
Art. Nr. 151049

Variante	Art. Nr.
1xGU10	
■ schwarz/chrom	144010
1xGU10	
weiß/chrom	144011
1xGU10	
■ kupfer	144019



Ligth Eye 150

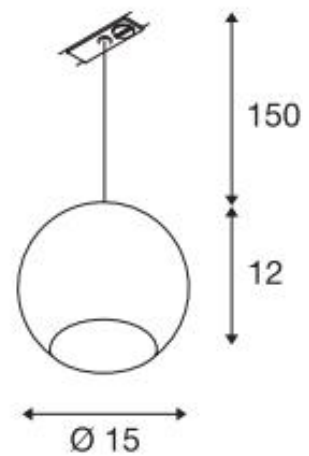

220-240V ~50/60Hz
Material: Stahl

QPAR111 | 12.5W | 30°
2700K | 950lm | EEK=F
13kWh/1000h

Art. Nr. 1005276



Variante	Art. Nr.
1xGU10	
■ schwarz/chrom	1000713
1xGU10	
weiß/chrom	143621

Forchini M 40 Track

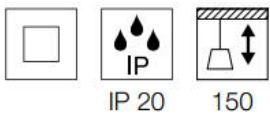
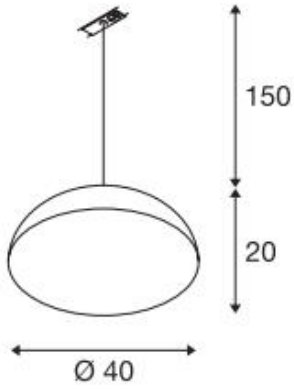

220-240V ~50/60Hz
Material: Aluminium / Stahl

LED E27 | 7,5W | 320°
2700K | 800lm | EEK=F
8kWh/1000h



Art. Nr. 1005303



Variante	Art. Nr.
1xE27 ■ schwarz/gold	143932



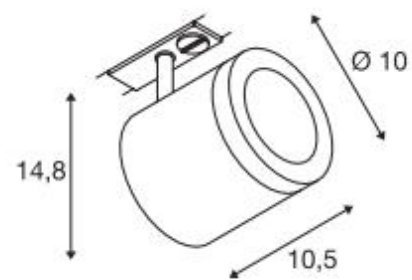
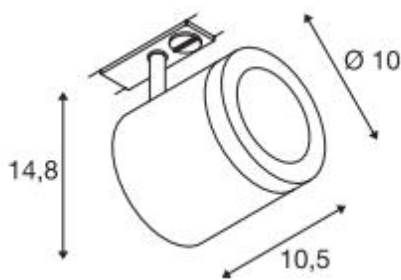
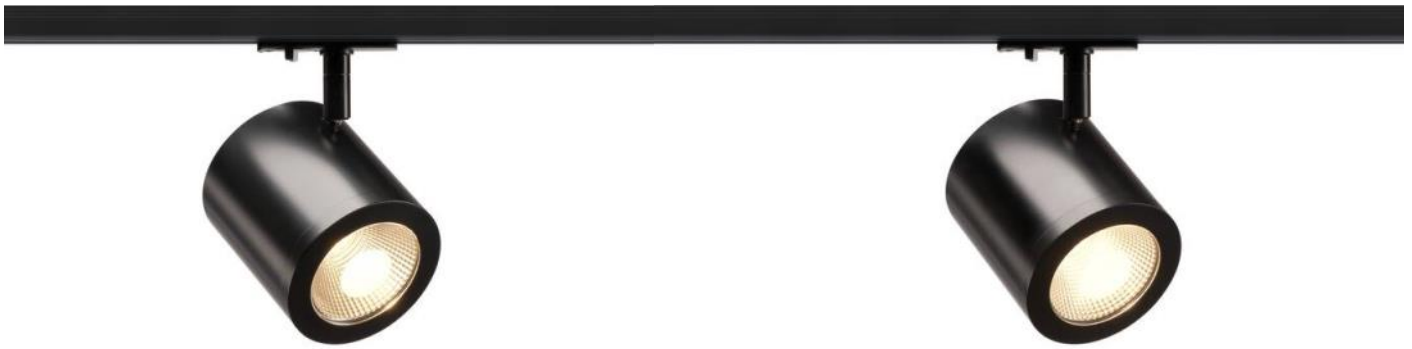

220-240V ~50/60Hz | 500mA
 Systemleistung: 11W
 Material: Aluminium / Glas

220-240V ~50/60Hz | 500mA
 Systemleistung: 11W
 Material: Aluminium / Glas

1000711, 143941	1040lm 3000K	

1000712, 143951	1040lm 3000K	

Variante	Art. Nr.
1040lm 3000K CRI80 35° ■ schwarz	1000711
1040lm 3000K CRI80 35° weiß	143941

Variante	Art. Nr.
1040lm 3000K CRI80 55° ■ schwarz	1000712
1040lm 3000K CRI80 55° weiß	143951



Enola B Track

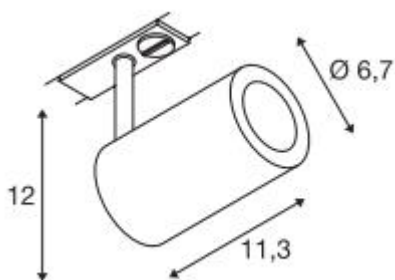

<50 W

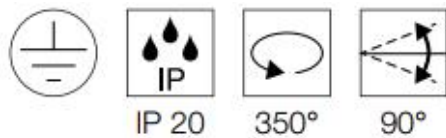

220-240V ~50/60Hz
Material: Aluminium / Stahl

LED GU10 51mm | 6W | 38°
3000K | 470lm | EEK=F
6kWh/1000h

Art. Nr. 1005079



Enola B



<50 W

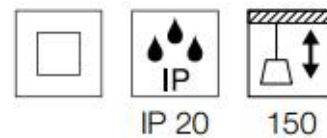

230V ~50Hz
Material: Aluminium / Stahl

LED GU10 51mm | 4W | 36°
2700K | 270lm | EEK=G
4kWh/1000h

Art. Nr. 1004972



Variante	Art. Nr.
1xGU10	
■ schwarz	1002110
1xGU10	
weiß	1002111
1xGU10	
■ grau	1002113

Variante	Art. Nr.
1xGU10	
■ schwarz	143960
1xGU10	
weiß	143961



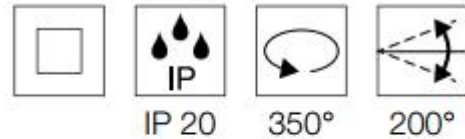
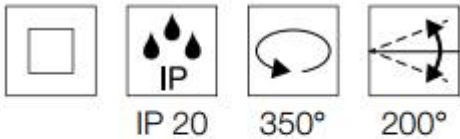
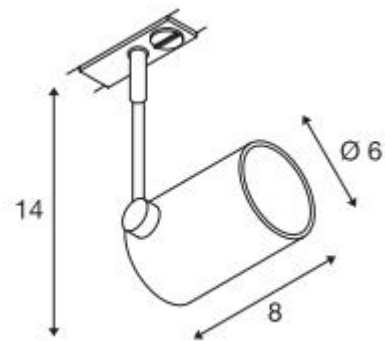
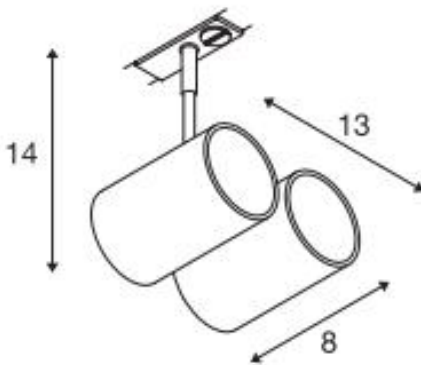

220-240V ~50/60Hz
Material: Aluminium

220-240V ~50/60Hz
Material: Aluminium

LED GU10 51mm | 4W | 36°
2700K | 270lm | EEK=G
4kWh/1000h

LED GU10 51mm | 6W | 38°
3000K | 470lm | EEK=F
6kWh/1000h

Art. Nr. 1004972



Art. Nr. 1005080



Variante	Art. Nr.
2xGU10	
■ schwarz	143430
2xGU10	
weiß	143431
2xGU10	
■ grau	143432

Variante	Art. Nr.
1xGU10	
■ schwarz	143440
1xGU10	
weiß	143441
1xGU10	
■ grau	143442



Noblo Spot

Helia 50 Track

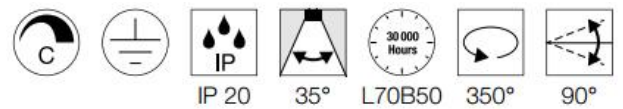
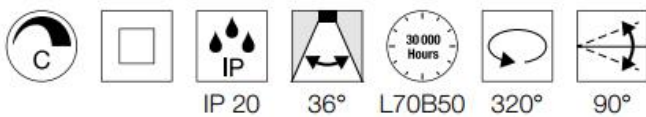
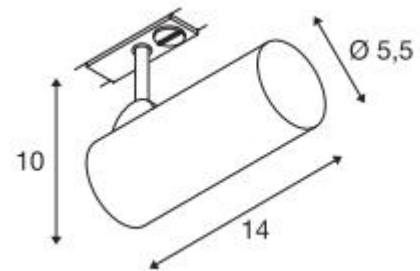
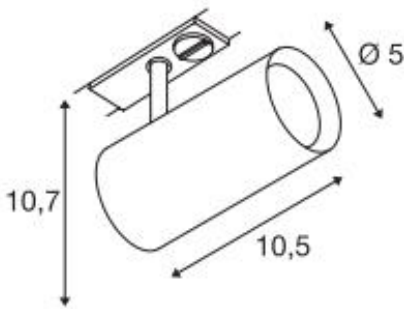
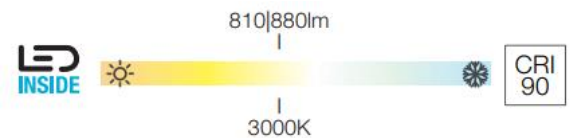

LED 220-240V ~50/60Hz | 150mA
Systemleistung: 6.2W
Material: Aluminium / Polycarbonat (PC)

LED 220-240V ~50/60Hz | 500mA
Systemleistung: 11W
Material: Aluminium

1001862, 1001863, 1001864	620lm 2700K	

143580, 143581	810lm 880lm 3000K	

Variante	Art.Nr.
● schwarz	1007638
○ weiß	1007639
● grau	1007640

Variante	Art. Nr.
810lm 3000K CRI90	
● schwarz	143580
880lm 3000K CRI90	
○ weiß	143581



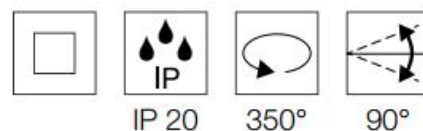
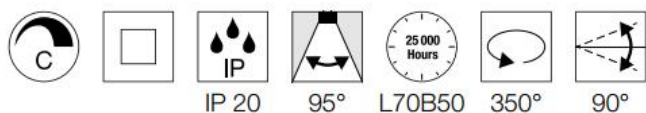
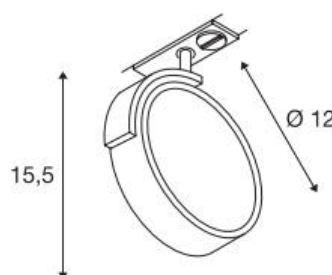
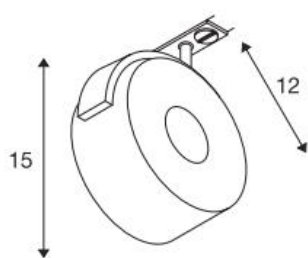
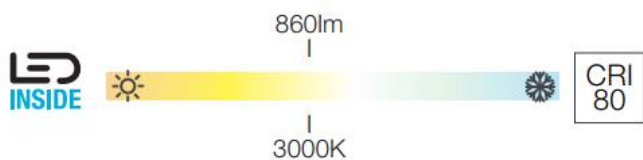

220-240V ~50/60Hz
Systemleistung: 13W
Material: Aluminium

220-240V ~50/60Hz
Material: Aluminium / Kunststoff

1002854, 143731	860lm 3000K	

QPAR111 | 12,5W | 30°
2700K | 950lm | EEK=F
13kWh/1000h

Art. Nr. 1005276



Variante	Art. Nr.
860lm 3000K CRI80 ■ schwarz	1002854
860lm 3000K CRI80 weiß	143731

Variante	Art. Nr.
1xGU10 ■ schwarz	143540
1xGU10 weiß	143541
1xGU10 ■ grau	143544

Euro Spot Track

Altra Dice Track

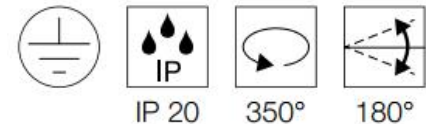
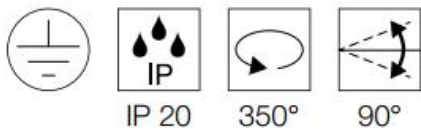
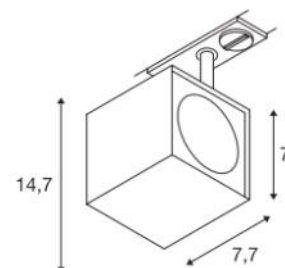
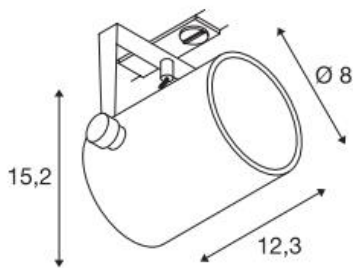

220-240V ~50/60Hz
Material: Aluminium / Glas

220-240V ~50/60Hz
Material: Aluminium

LED GU10 51mm | 6W | 38°
3000K | 470lm | EEK=F
6kWh/1000h

LED GU10 51mm | 6W | 38°
3000K | 470lm | EEK=F
6kWh/1000h

Art. Nr. 1005079



Art. Nr. 1005079



Variante	Art. Nr.
1xGU10	
■ schwarz	1001861
1xGU10	
weiß	143811

Variante	Art. Nr.
1xGU10	
■ schwarz	143350
1xGU10	
weiß	143351
1xGU10	
■ grau	143354



1-PHASEN

Aufbauschiene Planungshilfe und Zubehör auf einen Blick

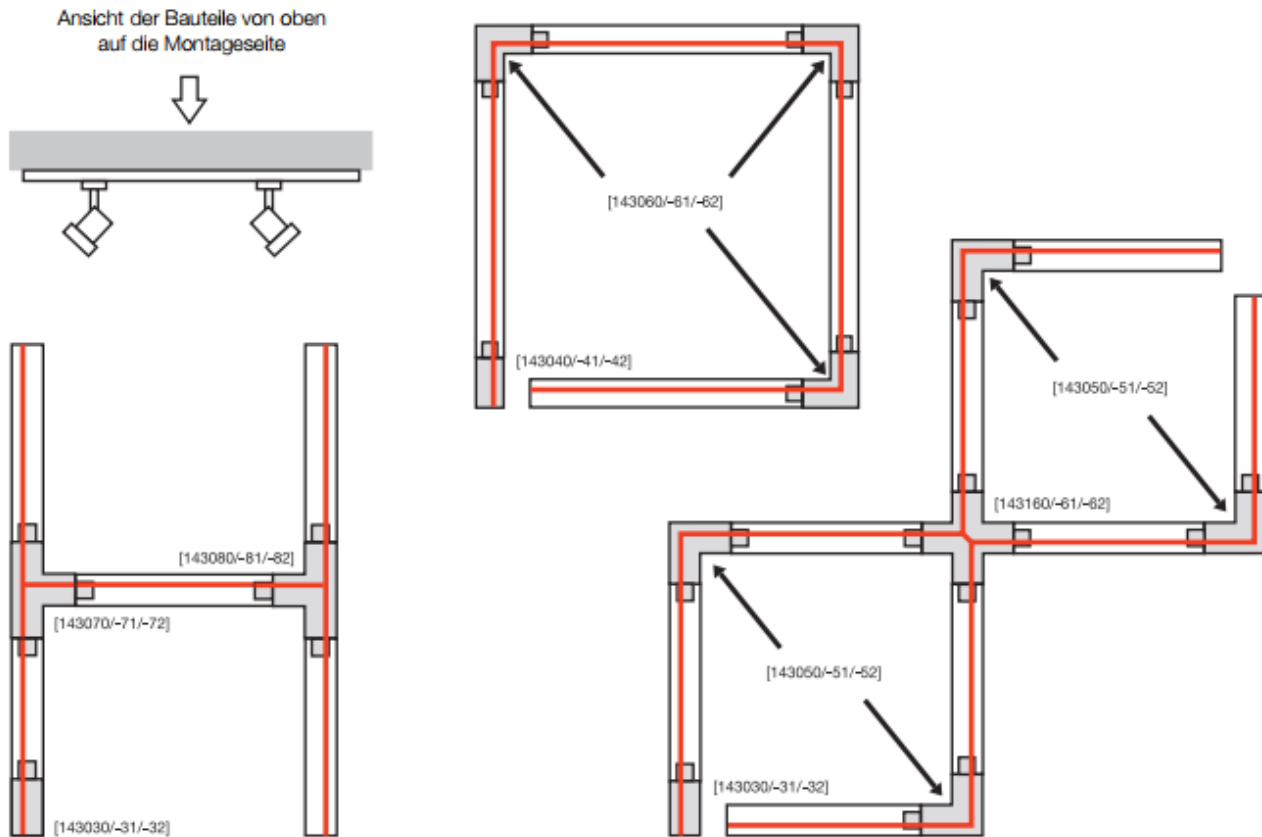

1-PHASEN

AUFBAUSCHIENE









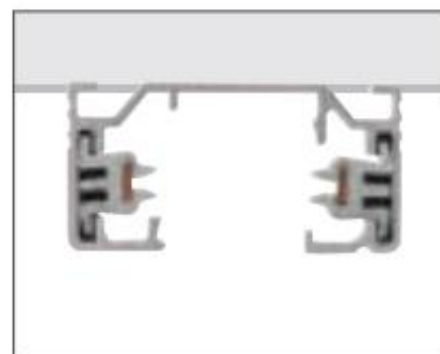











	1 m	1m	1 m
Nennspannung (V)	220-240V -50/60Hz	220-240V -50/60Hz	220-240V -50/60Hz
max. Stromstärke (A)	16	16	16
Material	Aluminium	Aluminium	Aluminium
Farbe	■ schwarz	weiß	■ grau
L x B x H (cm)	100 x 3,5 x 1,8	100 x 3,5 x 1,8	100 x 3,5 x 1,8
Art. Nr.	143010	143011	143012
CHF	42.65	42.65	42.65

	2 m	2 m	2 m
Nennspannung (V)	220-240V -50/60Hz	220-240V -50/60Hz	220-240V -50/60Hz
max. Stromstärke (A)	16	16	16
Material	Aluminium	Aluminium	Aluminium
Farbe	■ schwarz	weiß	■ grau
L x B x H (cm)	200 x 3,5 x 1,8	200 x 3,5 x 1,8	200 x 3,5 x 1,8
Art. Nr.	143020	143021	143022
CHF	85.00	85.00	85.00

	3 m	3 m	3 m
Nennspannung (V)	220-240V -50/60Hz	220-240V -50/60Hz	220-240V -50/60Hz
max. Stromstärke (A)	16	16	16
Material	Aluminium	Aluminium	Aluminium
Farbe	■ schwarz	weiß	■ grau
L x B x H (cm)	300 x 3,5 x 1,8	300 x 3,5 x 1,8	300 x 3,5 x 1,8
Art. Nr.	1002151	1002152	1002153



	<p>Einspeiser, Erde links 16A max. Polycarbonat (PC) L: 6,5 cm B: 3,5 cm H: 1,8 cm</p> <ul style="list-style-type: none"> ■ schwarz Art. Nr. 143030 ■ weiß 143031 ■ grau 143032 		<p>Stabilisator Längsverbinder Stahl L: 19,7 cm B: 3,2 cm H: 1,3 cm Zur Verstärkung bei Montage mehrerer Schienen mit Deckenabhangung (1002845)</p> <ul style="list-style-type: none"> ■ nickel Art. Nr. 143151
	<p>Einspeiser, Erde rechts 16A max. Polycarbonat (PC) L: 10,4 cm B: 3,5 cm H: 1,8 cm</p> <ul style="list-style-type: none"> ■ schwarz Art. Nr. 143040 ■ weiß 143041 ■ grau 143042 		<p>Stabilisator Eckverbinder Stahl L: 11,5 cm B: 11,5 cm H: 0,5 cm Zur Verstärkung bei Montage mehrerer Schienen mit Deckenabhangung (1002845)</p> <ul style="list-style-type: none"> ■ nickel Art. Nr. 143152
	<p>Längsverbinder* 16A max. Polycarbonat (PC) L: 17,2 cm B: 3,5 cm H: 1,8 cm</p> <ul style="list-style-type: none"> ■ schwarz Art. Nr. 143100 ■ weiß 143101 ■ grau 143102 		<p>Stabilisator X-Verbinder Stahl L: 19,7 cm B: 19,7 cm H: 0,5 cm Zur Verstärkung bei Montage mehrerer Schienen mit Deckenabhangung (1002845).</p> <ul style="list-style-type: none"> ■ grau Art. Nr. 143169
	<p>Längsverbinder 16A max. Polycarbonat (PC) L: 6,4 cm B: 3,5 cm H: 1,8 cm</p> <ul style="list-style-type: none"> ■ schwarz Art. Nr. 143090 ■ weiß 143091 ■ grau 143092 		<p>1-Phasen Leuchtenadapter 6A max. Polycarbonat (PC) L: 8,2 cm B: 3,5 cm H: 4,2 cm</p> <ul style="list-style-type: none"> ■ schwarz Art. Nr. 143120 ■ weiß 143121 ■ grau 143124
	<p>Eckverbinder, Erde innen 16A max. Polycarbonat (PC) L: 10,4 cm B: 10,4 cm H: 1,8 cm</p> <ul style="list-style-type: none"> ■ schwarz Art. Nr. 143060 ■ weiß 143061 ■ grau 143062 		<p>1-Phasen Leuchtenadapter mit Haken 6A max. Polycarbonat (PC) L: 8,2 cm B: 3,5 cm H: 7,4 cm</p> <ul style="list-style-type: none"> ■ schwarz Art. Nr. 143170 ■ weiß 143171 ■ grau 143172
	<p>Eckverbinder, Erde außen 16A max. Polycarbonat (PC) L: 10,4 cm B: 10,4 cm H: 1,8 cm</p> <ul style="list-style-type: none"> ■ schwarz Art. Nr. 143050 ■ weiß 143051 ■ grau 143052 		<p>Abdeckung Polycarbonat (PC) L: 200 cm B: 1,8 cm H: 0,75 cm</p> <ul style="list-style-type: none"> ■ schwarz Art. Nr. 1004783 ■ weiß 1004785 ■ grau 1004784
	<p>T-Verbinder, Erde außen links 16A max. Polycarbonat (PC) L: 17,2 cm B: 10,4 cm H: 1,8 cm</p> <ul style="list-style-type: none"> ■ schwarz Art. Nr. 143070 ■ weiß 143071 ■ grau 143072 		<p>Endkappe Polycarbonat (PC) L: 0,4 cm B: 3,5 cm H: 1,8 cm</p> <ul style="list-style-type: none"> ■ schwarz Art. Nr. 143130 ■ weiß 143131 ■ grau 143132
	<p>T-Verbinder, Erde außen rechts 16A max. Polycarbonat (PC) L: 17,2 cm B: 10,4 cm H: 1,8 cm</p> <ul style="list-style-type: none"> ■ schwarz Art. Nr. 143080 ■ weiß 143081 ■ grau 143082 		<p>Deckenrosette 6A max. Polycarbonat (PC) H: 2,5 cm Ø: 12,1 cm</p> <ul style="list-style-type: none"> ■ schwarz Art. Nr. 143380 ■ weiß 143381 ■ grau 143382
	<p>X-Verbinder 16A max. Polycarbonat (PC) L: 9,5 cm B: 17,2 cm H: 1,8 cm</p> <ul style="list-style-type: none"> ■ schwarz Art. Nr. 143160 ■ weiß 143161 ■ grau 143162 		<p>Drahtseilabhangung 2 Stück Edelstahl / Messing L: 500 cm max. 10 kg</p> <ul style="list-style-type: none"> ■ nickel Art. Nr. 1002845
	<p>Flexverbinder 16A max. Polycarbonat (PC) L: 16,4 cm B: 3,5 cm H: 1,8 cm</p> <ul style="list-style-type: none"> ■ schwarz Art. Nr. 143110 ■ weiß 143111 ■ grau 143112 		

1-PHASEN

Einbauschiene mit passendem Zubehör

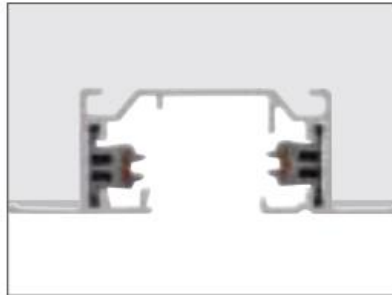

2 m

Nennspannung (V)	220-240V ~50/60Hz
max. Stromstärke (A)	16
Material	Aluminium
Farbe	weiß
L x B x H (cm)	200 x 5,5 x 1,8
Einbau-B (cm)	4
Art. Nr.	143221



Einspeiser, Erde links
 16A max. | Kunststoff
 L: 10,8 cm B: 5,5 cm H: 2 cm
 weiß Art. Nr. 143231



Endkappe
 Kunststoff
 L: 2,7 cm B: 5,5 cm H: 1,8 cm
 weiß Art. Nr. 143281



Einspeiser, Erde rechts
 16A max. | Kunststoff
 L: 10,8 cm B: 5,5 cm H: 2 cm
 weiß Art. Nr. 143241



Haltebügel
 Stahl
 L: 7,5 cm B: 1,5 cm H: 4 cm
 ■ nickel Art. Nr. 143230



Längsverbinder
 16A max. | Kunststoff / Stahl
 L: 6,5 cm B: 1,8 cm H: 1,7 cm
 weiß Art. Nr. 143271



1-Phasen-Adapter mit Haken
 6A max. | Polycarbonat (PC)
 L: 8,2 cm B: 3,5 cm H: 7,4 cm
 ■ schwarz Art. Nr. 143170
 ■ weiß 143171
 ■ grau 143172



Eckverbinder, Erde innen
 16A max. | Kunststoff
 L: 11,2 cm B: 11,2 cm H: 2 cm
 weiß Art. Nr. 143261



1-Phasen Leuchtenadapter
 6A max. | Polycarbonat (PC)
 L: 8,2 cm B: 3,5 cm H: 4,2 cm
 ■ schwarz Art. Nr. 143120
 ■ weiß 143121
 ■ grau 143124



Eckverbinder, Erde außen
 16A max. | Kunststoff
 L: 11,2 cm B: 11,2 cm H: 2 cm
 weiß Art. Nr. 143251



lichtmacher

Wir bringen Licht

„ Dunkelheit existiert nicht, nur die Abwesenheit von Licht. “



Dies ist nur ein kleiner Ausschnitt aus unserem Gesamtsortiment.
Fragen Sie uns an.