

# lichtmacher

*Neuheiten 2021.1*



# SHOT LIGHT M SURFACE



## SHOT LIGHT M SURFACE

A396-00-10-	WT	NT	MC	MG	WTW	NTMG	4,5-12,4W	2700K	660-1470Lm	86%
A396-00-11-	WT	NT	MC	MG	WTW	NTMG	4,5-12,4W	3000K	690-1530Lm	86%
A396-00-12-	WT	NT	MC	MG	WTW	NTMG	4,5-12,4W	4000K	700-1550Lm	86%

LED | 220/240 V~ | CE | III | IP20 | CRI>90 | L80B10 >60.000h

MacAdam Step 2

REMOTE EXCL\*

UGR <19

38°

COLOUR | WT   | NT   | MG   | MC   | NTMG   | WTW   | MATERIAL |  AL |  PC | RAL

\*\* OTHER FINISHING COMBINATIONS PLEASE CONSULT



## GRÖSSE

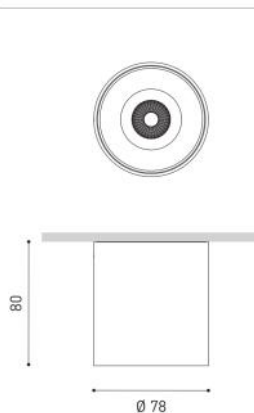



**Verwendung von CS (Beton)-Federn (Beton/Gyproc)**

Für 5-80 mm Deckenstärke.  
Einbautiefe 80 mm (inkl. 5 mm Platz für Belüftung).

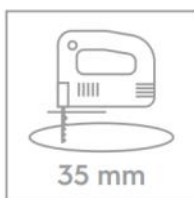

Nur wenn das Produkt in eine geschlossene Decke eingebaut wird, darf es Spritzwasser ausgesetzt werden, und zwar nur auf der Vorderseite.



\* Dieser Abstand ist notwendig wegen der Höhe des Anschlussdose (80 mm). Aus reinem Wärme Aspekt reichen 5 mm aus.

\*\* Bei WS-Federn beträgt dieses Mass ist 60 mm

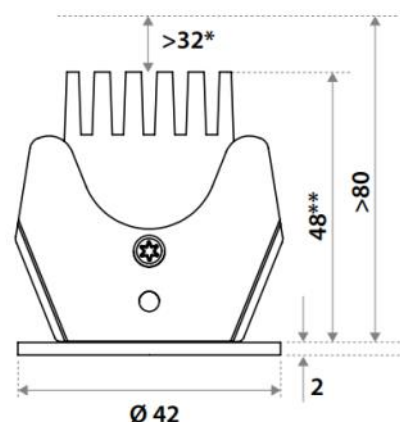

**SPECIFICATIONS**

Beam angle (FWHM)	40° (65° FWTM)
Fixture material	Housing: Die cast aluminium / Reflector glass: Polycarbonate
Environment	Indoor
IK rate	IK03
Operating temperature (Ta)	-20°C / +45°C <sup>1</sup>
Safety marks	EN60598 / EN62031 / EN62471
EMC compliance	EN55015
Colour consistency (SDCM)	MacAdam step 3
Energy class	A
Converter	EXCL.

**FLUXE 35 VARIATIONS**

Ic 0135035/6    350mA    to be connected to a central power supply

**ITEM SPECIFICATIONS (PART A)**

Description	Input	Vf	W	Lm	Lm/W	CRI (typ.)	UGR	Pf	Ripple	Inrush current	B-16A Fuse	Colors black	white
Fluxe 35 LV-C 350mA 400 Lm 3000K Dim	350mA	11,9	4,5	400	89	82	14,4	x	x	x	x	Ic 0135035	Ic 0135036

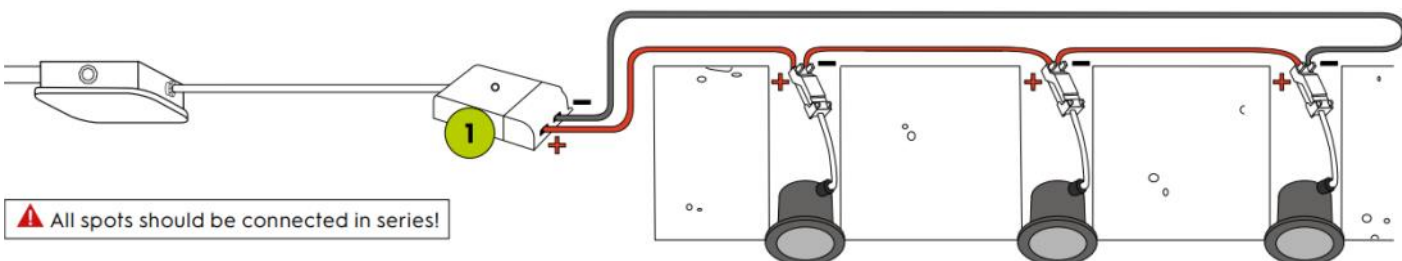

**⚠ All spots should be connected in series!**

# Faro – RUSH



# Rush

— Estudi Ribaudí 

Body Aluminium/Aluminio  
Diff Transparent Polycarbonate/  
Policarbonato transparente



BEACON



 | IP65 | CRI90 | IK10 | 100-240V | 50-60Hz |  Driver incl. |  optional |  optional

— Estudi Ribaudí 

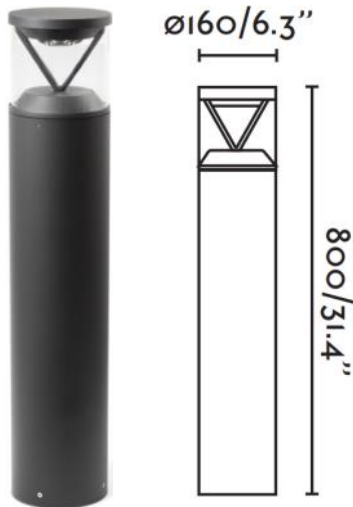

BOLLARD



STANDARD Driver incl. 

\*DALI option

 professional led applications

\*CASAMBI option

 professional led applications

VOSSLOH-SCHWABE  
Beacon mA 350mA  
Bollard mA 500mA  
V 100-240V  
Hz 50-60Hz  
Power factor 0.90  
Low ripple <30%  
Lifetime 50000h  
Overload protection  
Short-circuit protection  
Overheating protection  
SELV (Safety Extra Low Voltage)

TCI  
Beacon mA 350mA  
Bollard mA 500mA  
V 220-240V  
Hz 50-60Hz  
Power factor 0.95  
Low ripple <3%  
Lifetime 50000h  
DALI-2 dimmable  
PUSH SWITCH compatible  
Overload protection  
Short-circuit protection  
Overheating protection  
SELV (Safety Extra Low Voltage)

TCI  
Beacon mA 350mA  
Bollard mA 500mA  
V 220-240V  
Hz 50-60Hz  
Power factor 0.95  
Low ripple <3%  
Lifetime 50000h  
DALI-2 dimmable  
PUSH SWITCH compatible  
Overload protection  
Short-circuit protection  
Overheating protection  
SELV (Safety Extra Low Voltage)

# Rush

**Body** Aluminium/Aluminio  
**Diff** Transparent Polycarbonate/  
 Policarbonato trasparente



**COB LED**  
**MacAdam Steps**  
**Risk Group**  
**Lumen maintenance**  
**Heat dissipation**

**VOSSLOH-SCHWABE**  
 2  
 1  
 L90 B10 up to 89.000h  
 Tested at high ambient temperature

IP65 | CRI90 | IK10 | 100-240V | 50-60Hz | Driver incl. | DALI optional | CASAMBI optional

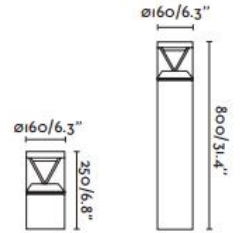

Rush Beacon 14W	CCT	FLUX	LENS
750000	2700K	830lm	360°
750000D Dali	2700K	830lm	360°
750000C Casambi	2700K	830lm	360°
750001	2700K	980lm	360° Wide
750001D Dali	2700K	980lm	360° Wide
750001C Casambi	2700K	980lm	360° Wide
750002	2700K	795lm	180°
750002D Dali	2700K	795lm	180°
750002C Casambi	2700K	795lm	180°
750010	3000K	830lm	360°
750010D Dali	3000K	830lm	360°
750010C Casambi	3000K	830lm	360°
750011	3000K	980lm	360° Wide
750011D Dali	3000K	980lm	360° Wide
750011C Casambi	3000K	980lm	360° Wide
750012	3000K	795lm	180°
750012D Dali	3000K	795lm	180°
750012C Casambi	3000K	795lm	180°
750020	4000K	830lm	360°
750020D Dali	4000K	830lm	360°
750020C Casambi	4000K	830lm	360°
750021	4000K	980lm	360° Wide
750021D Dali	4000K	980lm	360° Wide
750021C Casambi	4000K	980lm	360° Wide
750022	4000K	795lm	180°
750022D Dali	4000K	795lm	180°
750022C Casambi	4000K	795lm	180°

Rush Bollard 20W	CCT	FLUX	LENS
750100	2700K	1147lm	360°
750100D Dali	2700K	1147lm	360°
750100C Casambi	2700K	1147lm	360°
750101	2700K	1355lm	360° Wide
750101D Dali	2700K	1355lm	360° Wide
750101C Casambi	2700K	1355lm	360° Wide
750102	2700K	1103lm	180°
750102D Dali	2700K	1103lm	180°
750102C Casambi	2700K	1103lm	180°
750110	3000K	1147lm	360°
750110D Dali	3000K	1147lm	360°
750110C Casambi	3000K	1147lm	360°
750111	3000K	1355lm	360° Wide
750111D Dali	3000K	1355lm	360° Wide
750111C Casambi	3000K	1355lm	360° Wide
750112	3000K	1103lm	180°
750112D Dali	3000K	1103lm	180°
750112C Casambi	3000K	1103lm	180°
750120	4000K	1147lm	360°
750120D Dali	4000K	1147lm	360°
750120C Casambi	4000K	1147lm	360°
750121	4000K	1355lm	360° Wide
750121D Dali	4000K	1355lm	360° Wide
750121C Casambi	4000K	1355lm	360° Wide
750122	4000K	1103lm	180°
750122D Dali	4000K	1103lm	180°
750122C Casambi	4000K	1103lm	180°

# LUCKY SYSTEM – EVO



OPALDIFFUSOR ODER BLENDSCHUTZDIFFUSOR  
MIT MIKROSTRUKTURIERTER FILM BIS ZU L. 6 m  
SCHNELLVERBINDER FÜR DIE DURCHGEHENDE  
LEITUNGSINSTALLATION



MINI



EVO B



MAXI

# LUCKY SYSTEM

INSTALLAZIONI  
INSTALLATION

## LUCKY MAXI

- .01 Bianco - White
- .02 Nero - Black

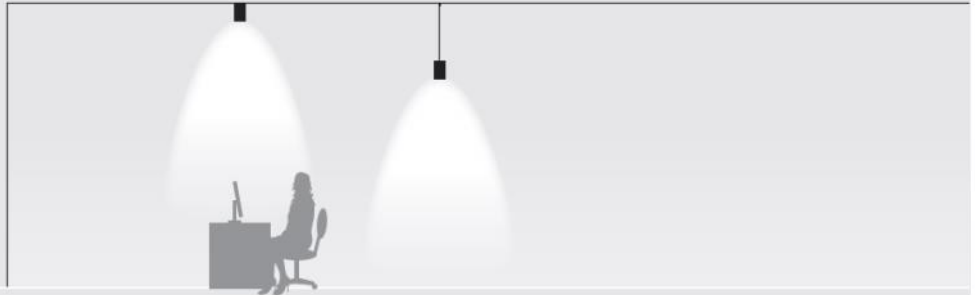

## LUCKY EVO

- .01 Bianco - White
- .02 Nero - Black

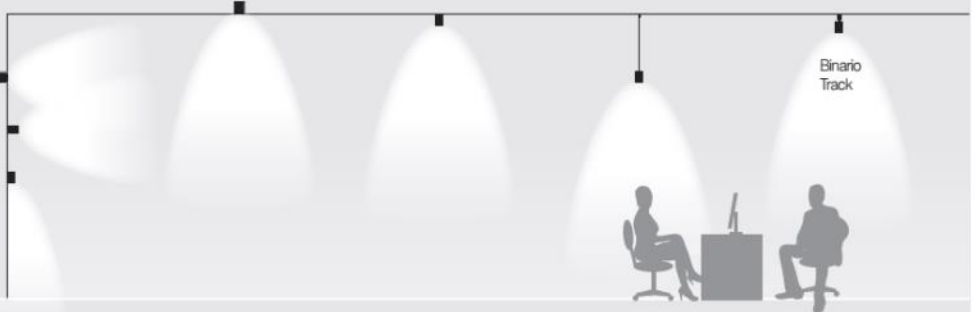

## LUCKY EVO B

- .01 Bianco - White
- .02 Nero - Black

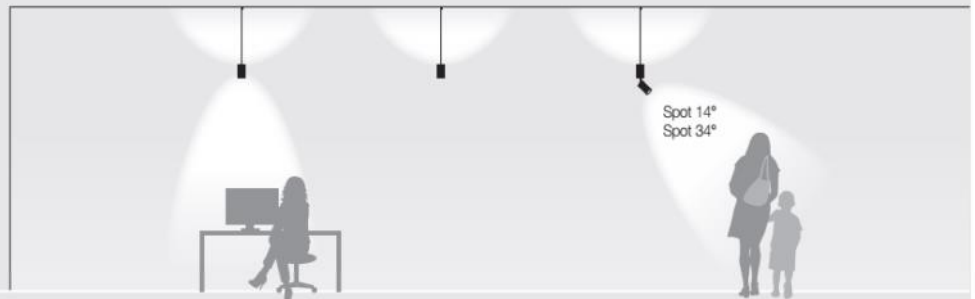

## LUCKY EVO C

- .01 Bianco - White

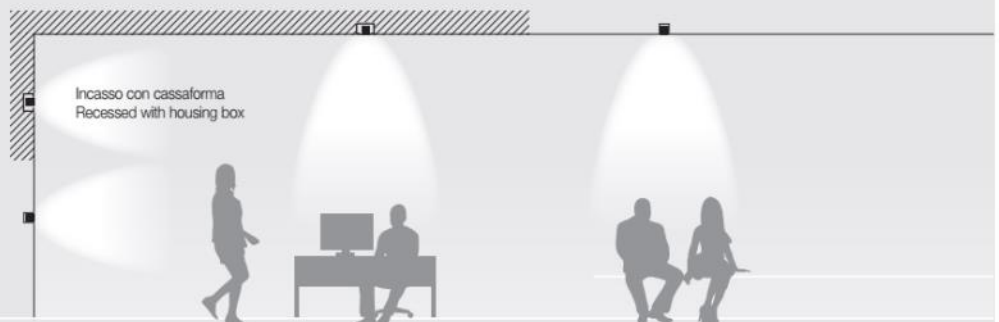

## LUCKY MINI

- .01 Bianco - White
- .02 Nero - Black



# BLINK

13W & 27W

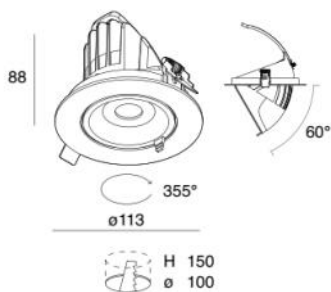

**BLINK 13W**  
350mA

POWER	BEAM	FLUX	3000K <input type="checkbox"/>	FLUX	4000K <input type="checkbox"/>
13W	55°	1008 lm	<b>107801.01</b>	1112 lm	<b>107802.01</b>

**DALI - PUSH - 1-10V**

POWER	BEAM	FLUX	3000K <input type="checkbox"/>	FLUX	4000K <input type="checkbox"/>
13W	55°	1008 lm	<b>107805.01</b>	1112 lm	<b>107806.01</b>

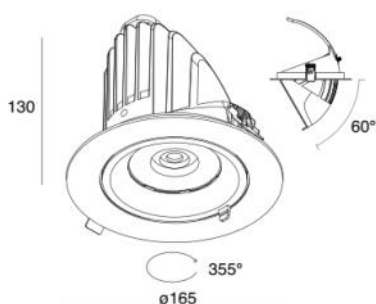

**BLINK 27W**  
700mA

POWER	BEAM	FLUX	3000K <input type="checkbox"/>	FLUX	4000K <input type="checkbox"/>
27W	55°	2065 lm	<b>107803.01</b>	2326 lm	<b>107804.01</b>

**DALI - PUSH - 1-10V**

POWER	BEAM	FLUX	3000K <input type="checkbox"/>	FLUX	4000K <input type="checkbox"/>
27W	55°	2065 lm	<b>107807.01</b>	2326 lm	<b>107808.01</b>

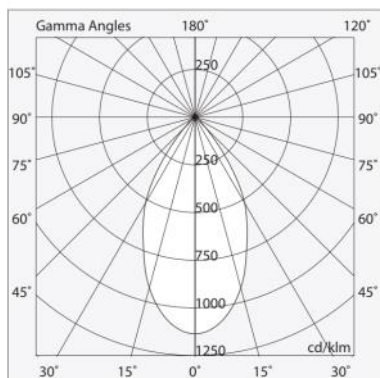
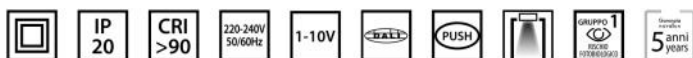

BEAM 55°

EINBAUDOWNLIGHT VERSTELLBAR UND ABNEHMBAR BIS ZU EINEM WINKEL VON 60°. GUT GEEIGNET FÜR DIE AUSLEUCHTUNG KLEINER UND GROSSER RÄUME, SOWOHL WO SIE DIFFUSES LICHT BENÖTIGEN DANK DES BREITEN ABSTRAHLWINKELS VON 55°, ALS AUCH ZUR FOKUSIERUNG VON DETAILS DURCH DIE WECHSELOPTIK MIT ENGEM STRAHL 24°.





DURCH DEN SPEZIELLEN QUERSCHNITT DES TUNO-WAVE-PROFILES KANN SOWOHL DER TRAFU INTEGRIERT, ALS AUCH DIREKTES BZW. DIREKT/INDIREKTES LICHT ERZEUGT WERDEN. DIES BEWÄHRT SICH SOWOHL BEI PENDEL-, DECKEN-, ALS AUCH WANDLEUCHTEN. DAS PROFIL KANN MAN AUF WUNSCH IN DIV. FARBEN ERHALTEN. FALLS ES KÜRZER ODER LÄNGER SEIN SOLL, KEIN PROBLEM, WIR KONFEKTIONIEREN ES GERNE SPEZIELL AUF IHRE MASSE.

Licht direkt

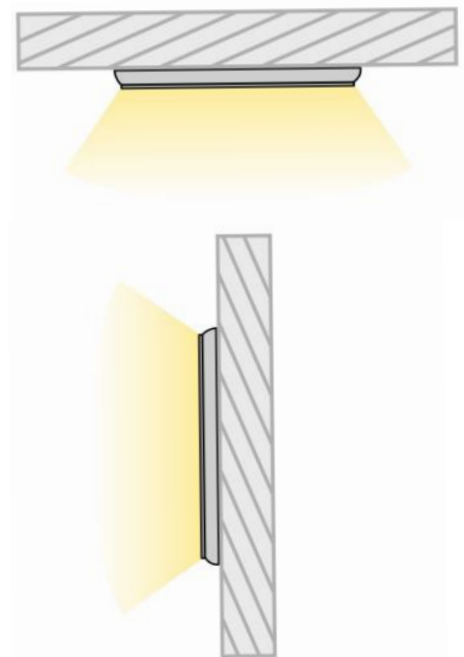
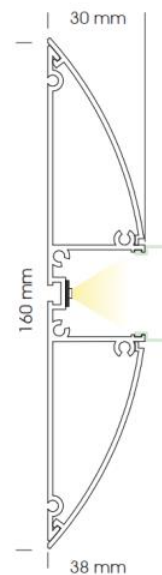

Licht direkt	Länge	Daten	weiss	schwarz	silber	nickel
Tuno-Wave 57226	320mm (-32)	570 Lm 8W	57226-32-02	57226-32-03	57226-32-15	57226-32-16
	520mm (-52)	954 Lm 11W	57226-52-02	57226-52-03	57226-52-15	57226-52-16
	720mm (-72)	1'362 Lm 15W	57226-72-02	57226-72-03	57226-72-15	57226-72-16
	920mm (-92)	1'770 Lm 20W	57226-92-02	57226-92-03	57226-92-15	57226-92-16

230V
LED
WW / TW
IP20
⏚
Driver inkl.
CE

Profilfarbe Standard /profile color standard	-02 weiß matt / white matt RAL 9010	-03 schwarz matt / black matt RAL 9005M	-15 silber eloxiert / silver anodised
Profilfarbe Premium /profile color premium	-16 nickel gebürstet nickel brushed		

# RONDOS



Artikelnr. /article no.	LED	3000K / 4000K	Durchmesser /diameter	
56717A-30-80/EX	10W max.	TW 1.900 WW 1.800 Lumen	direkt / indirektes Licht	Ø 300 mm
56717A-40-80/EX	19W max.	TW 3.500 WW 3.360 Lumen	direkt / indirektes Licht	Ø 400 mm
56717A-60-80/EX	37W max.	TW 4.900 WW 4.760 Lumen	direkt / indirektes Licht	Ø 600 mm
56717A-90-80/EX	50W	TW 9.600 WW 9.400 Lumen	direkt / indirektes Licht	Ø 900 mm



Profilfarbe Exklusivbeschichtung /profil color exklusive coating	-40 gold /gold	-41 blattgold /gold leaf	-42 blattsilber /silver leaf	-43 bronze /bronze	-44 kupfer antik, gespachtelt /antique copper, filled	-45 rost, gespachtelt /rust, filled
	-46 beton, gewalzt /concrete, rolled	-47 eisenglimmer, gewalzt /iron mica, rolled	-48 eisen, gespachtelt /iron, filled	-49 eisen matt /iron matt	-50 schiefer /slate	-51 rost /rust

230V
LED
IP20

Driver inkl.
CE
WW -3000K
TW -4000K

Sonderfarben auf Anfrage möglich | Lumenwerte beziehen sich auf LED Platine

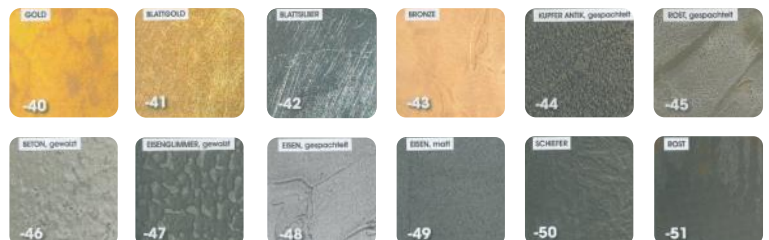
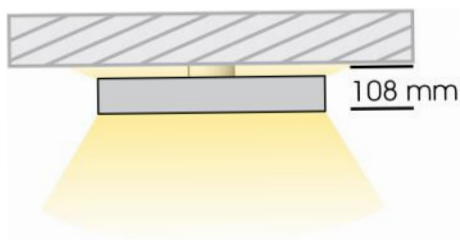

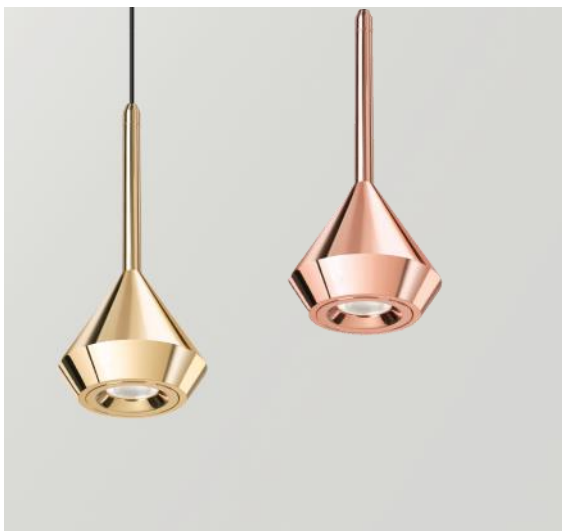
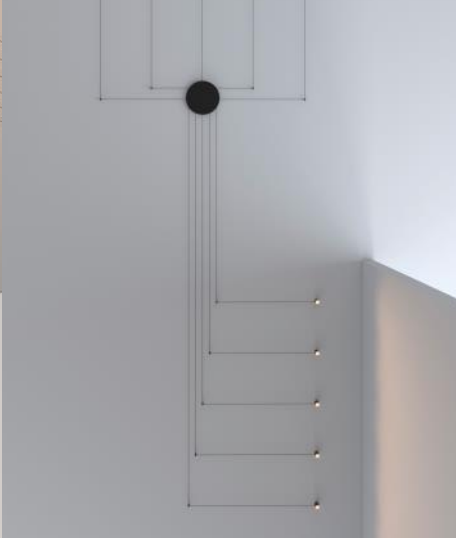

# lichtmacher

Wir bringen Licht

„ Dunkelheit existiert nicht, nur die Abwesenheit von Licht. “



Dies ist nur ein kleiner Ausschnitt aus unserem Gesamtsortiment.  
Fragen Sie uns an.